

# Mounting instructions

tile roof

side-fix

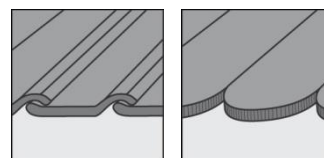

## TABLE OF CONTENTS

<b>1</b>	<b>Notes</b>	<b>1</b>
<b>2</b>	<b>Maintenance of the mounting system</b>	<b>4</b>
<b>3</b>	<b>novotegra for tile roofs</b>	<b>4</b>
<b>4</b>	<b>System components, tools and equipment</b>	<b>5</b>
4.1	What is required for mounting	5
4.2	Mounting system components – mounting versions	7
4.3	Mounting system components – optional	8
<b>5</b>	<b>Installing the mounting system</b>	<b>9</b>
5.1	Roof hook mounting: insertion system	9
5.2	Rail mounting: insertion system	10
5.3	Module mounting: insertion system	11
5.4	Insertion system mounting versions	12
5.5	Roof hook mounting: clamping system	14
5.6	Rail mounting: clamping system	15
5.7	Module mounting: clamping system	16
5.8	Clamping system mounting versions	17
<b>6</b>	<b>Warranty / product liability (exclusion)</b>	<b>20</b>

# 1 Notes

The following instructions are generally valid for our mounting system novotegra and are to be applied or interpreted accordingly regardless of the respective roof and mounting system type.

## Safety information

Mounting tasks may only be carried out by qualified and competent persons. During the work protective clothing in accordance with the relevant national regulations and guidelines must be worn.

Mounting must be carried out by at least two persons to ensure help in case of an accident.

All relevant national and locally applicable health and safety regulations, accident prevention regulations, standards, construction standards and environmental protection regulations as well as all regulations of the employers' liability insurance associations must be complied with.

The national regulations for working at height / on the roof must be complied with.

Electrical work must be carried out in compliance with the national and locally applicable standards and guidelines and the safety rules for electrical work.

Earthing / equipotential bonding of the mounting system must be carried out in accordance with the national and locally applicable standards and guidelines.

## Categorisation into hazard classes

To alert the user of potential danger situations the hazard classes analogous to ANSI Z 535 are used. The hazard class describes the risk if the safety information is not observed.

Warning symbol with signal word

Hazard class analogous to ANSI Z 535



**DANGER!** describes an immediate danger. If it is not avoided, death or serious injury will result.



**WARNING!** describes a potential danger. If it is not avoided, death or serious injury might result.



**CAUTION!** describes a potential danger. If it is not avoided, light or minor injury might result.



**NOTE!** describes a potentially harmful situation. If it is not avoided, the plant or objects in its vicinity might be damaged.

## General information

After receipt the goods must be inspected for completeness using the accompanying delivery note.

novotegra GmbH does not accept the costs, nor can we guarantee subsequent express deliveries if missing material is only noticed during mounting.

Since our mounting systems are subject to continuous development, mounting processes or components may change. Therefore, please check the current status of the mounting instructions on our website prior to mounting. We are also happy to send you current versions upon request.

The mounting system is suitable for the attachment of PV modules with standard market dimensions. Please find more detailed information about this in chapter 3.

The usability of the mounting system for the respective project must be checked for each individual case on the basis of the roof cover / roof construction / facade present.

The roof cover / roof construction / facade must meet the requirements of the mounting system with regard to load bearing capacity, support structure and condition.

Requirements for the material of the roof construction / roof cover / facade:

Wooden components (rafters/purlins): min. strength class C24, no fungus infection or rot

Tensile strength  $R_m$ , min for trapezoidal metal: steel 360 N/mm<sup>2</sup>; aluminium 195 N/mm<sup>2</sup>

Wall construction material: concrete, brick or sand-lime brick in solid or hollow block design.

The load bearing capacity of the roof / roof construction (rafters, purlins, trapezoidal metal, concrete floors, number of adhesive points, folded seams, etc.) or the facade (wall construction materials) must be checked by the user or a check be commissioned.

Physical building aspects concerning insulation penetrations (e.g. condensation) must be taken into account by the user.

## Notes on mounting

The components of the novotegra mounting system are intended exclusively for the attachment of PV modules. Dependent on the roof type of the building the designated mounting system components must be used.

A condition for the intended use of the novotegra mounting system is the mandatory compliance with the specifications in these instructions regarding safety information and mounting.

In case of unintended use and non-compliance with the safety information and mounting instructions and non-utilisation of the corresponding mounting components or use of third party components not belonging to the mounting system any warranty and liability claims against the manufacturer are voided. The user is liable for damage and resulting consequential damage to other components, such as PV modules, or the building as well as personal injury.

The user must read the mounting instructions prior to mounting. Unresolved issues must be clarified with the manufacturer prior to mounting. The mounting sequence in these instructions must be adhered to.

It must be ensured that a copy of the mounting instructions is accessible in the immediate vicinity of the work on site.

The mounting specifications (module load, attachment, clamping areas etc.) of the module manufacturer must be observed and complied with.

Prior to mounting the mounting system must be statically calculated with the loads to be assumed for the building project in accordance with the national standards. Information relevant to mounting (e.g. roof hook distance, lengths of bolts, overhang and protrusions or distance of base trough and required ballast) must be determined by the static calculation using the design software [www.solar-planit](http://www.solar-planit).

The permissible roof inclination for using the mounting system according to these installation instructions is 0 to 60 degrees for roof-parallel installation on a pitched roof and 0 to 5 degrees for elevated installation on a flat roof. Facade systems must be mounted parallel to the facade.

For roof-parallel installation with the clamping system, two module support rails per module must be mounted symmetrically under the modules for equal load transfer into the substructure. Alternatively, the roof-parallel installation can also be installed with insertion rails.

The specified tightening torques must be adhered to and checked randomly on site.

## Notes on static calculations

The mounting system must generally be statically calculated for each individual project using the design software Solar-Planit. Excluding façade systems, the calculation for this will be carried out by the company novotegra GmbH.

The static calculation only determines the load bearing capacity of the novotegra mounting system and also takes account of the attachment to the building (rafters, purlins, trapezoidal metal, facade etc.). The load transfer within the building is not considered (customer static calculations).

The load bearing capacity of the mounting system components is determined on basis of the planned module layout and the underlying building information (project data recording). Deviations from the planning on site may lead to different results.

The load assumptions (load and roof division) are country-specific in accordance with the specifications of the Eurocode load standards. The determination of the loads to be assumed for Switzerland is in accordance with SIA 261.

At pitched roof, the modules may not be fitted above the gable end, ridge and eaves or the facade (increased wind load). At the ridge the modules may be fitted up to max. a theoretical horizontal line with the ridge tile and perfectly flush with the gable end. In the eaves area the modules may reach to max. the end of the roof cover due to loads.

In case of an exposed building position (with wind load e.g. at the edge of a slope) or snow accumulation (e.g. dormer or catchment grill or roof structures like domelights etc) the specifications of the Eurocode load standards or SIA 261 (Switzerland) must be taken into account by the user within his own responsibility. The design software does not consider these cases.

The static calculation of the mounting system is based on the symmetrical placement of the modules on the mounting rails at the longitudinal side of the modules (roof-parallel clamping systems) or on the support components (elevation) for equal load transfer into the substructure. For the insertion system a cross rail arrangement is expected for equal load transfer.

The results calculated with the design software, such as distances of the fasteners (e.g. roof hooks, stock screws, saddle clamps etc.), rail lengths and number of fasteners (e.g. direct attachment on the trapezoidal metal), overhang (e.g. rail and roof hook protrusions) or distances between the base troughs and number of fixing materials (e.g. rail joint) and the other calculation notes must be considered and complied with.

novotegra has been tested and certified by TÜV Rheinland:



## **2 Maintenance of the mounting system**

The mounting system must be checked for stability and operation at regular intervals during the system maintenance.

In addition to the visual inspection of the components, we recommend a random check of the connections and the safe and correct position of the ballast on the base rails and ballast troughs.

Removal is possible in reverse order in the work steps mentioned below.

The maintenance work must be carried out by a specialist company with proven experience in electrical systems and work on mounting systems.









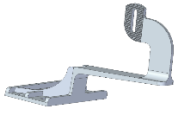

## **3 novotegra for tile roof**

These mounting instructions the design of the substructure on roofs with clay tiles, concrete roof tiles or plain tile covering. The maximum permissible module width is 1.34 m for the respective mounting system to be used.

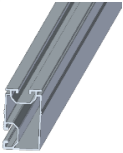
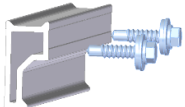
The mounting steps can be applied correspondingly to the installation on roofs with slate covering. However, in the area where the roof hooks exit the roof cover hoods or lead flashing is required to prevent water ingress. Please contact us for support in advance of such mounting tasks.

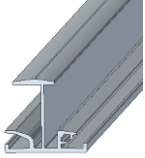
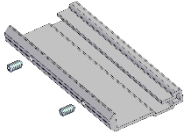
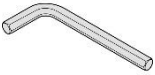
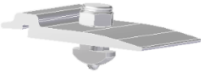

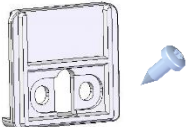





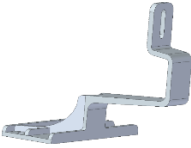

## 4 System components, tools and equipment

### 4.1 What is required for mounting

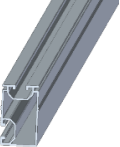
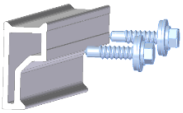



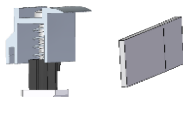

Insertion system			
Figure	Tool	Component*	Product group
		Roof hook ZD 533 Material: Cast aluminium Tool: Socket AF 13	Roof attachment
		Roof hook mounting screw Material: Galvanised steel or stainless steel Tool: Torx TX 40 or 25	Roof attachment
		N-rail Material: Aluminium	Profile rails
		Rail connector set N Material: Aluminium and stainless steel Tool: Socket AF 8	Rails connectors and expansion joints
		Insertion rail Material: Aluminium	Profile rails
		Rail Connector set IR Material: Aluminium and stainless steel Tool: Hexagon socket AF 3	Rails connectors and expansion joints
		Cross rail connector set N IR Material: Aluminium and stainless steel Tool: Socket AF 13	Rails connectors and expansion joints
		Edge stop set IR Material: Aluminium and stainless steel Tool: Torx TX bit 30	Module protection and rail top cover

\* The components vary dependent on the roof requirements, the static calculation or the component selection and may differ from the figures above.

## Clamping system

Figure	Tool	Component*	Product group
		Roof hook ZD 544 Material: Cast aluminium Tool: Socket AF 13	Roof attachment
		Roof hook mounting screw Material: Galvanised steel or stainless steel Tool: Torx bit TX 40 or 25	Roof attachment
		N-rail Material: Aluminium	Profile rails
		Rail connector set N Material: Aluminium and stainless steel Tool: Socket AF 8	Rails connectors and expansion joints
		Middle clamp sets N Material: Aluminium and stainless steel Tool: AW30 drive	Module attachment
		End clamp sets N and spacer Material: PA 6.6, aluminium and stainless steel Tool: AW30 drive	Module attachment
		Module slip guard set Material: stainless steel	Module protection and rail top cover

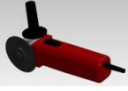



\* The components vary dependent on the roof requirements, the static calculation or the component selection and may differ from the figures above.

Figure	Equipment	Use for tools	Application
	Battery-operated screwdriver	Torx bit or AW drive Socket AF 8	Component attachments, clamp mounting
	Torque spanner up to min. 50 Nm	Special socket AF 18 deep	Rail assembly
	Torque spanner up to min. 12 Nm	Socket AF 8	Clamp assembly
	Mitre saw	---	Rail section
	Angle grinder	---	Tile adaptation
	Bit extension	Torx bit or AW drive	Roof hook mounting

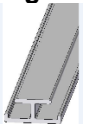

## 4.2 Mounting system components – mounting versions

### Insertion system





Figure	Tool	Component**	Product group
		Support rail IR Material: Aluminium	Profile rails
		Insertion Rail Plus Material: Aluminium	Profile rails
		EPDM-T protection IR Material: EPDM	Module protection and rail top cover
		Mounting set snowguard IR Material: Aluminium and stainless steel Tool: Socket AF 8	Optional components
		Snowguard IR 20 x 5 Alu round pipe Material: Aluminium	Rail
		Edge stop set IR Plus Material: Aluminium and stainless steel Tool: Torx bit TX 30	Rail cover

### Clamping system

Figure	Tool	Component**	Product group
		Roof hook BS C-shape stainless steel Material: stainless steel and galvanised steel Tool: AW30 drive	Roof attachment
		L adapter set N-rail to C-shape roof hook Material: Aluminium and stainless steel Tool: Hexagon socket AF 6, nut AF 13, nut AF 15	Optional components
		Cross rail connector set N Material: Aluminium and stainless steel Tool: Socket AF 13	Rails connectors and expansion joints

\*\* Required components dependent on the substructure (e.g. cross rail arrangement) or module layout (e.g. mounting modules in landscape).

### 4.3 Mounting system components – optional

Figure	Tool	Component***	Product group
		Roof hook support plate Material: PE	Optional components
		End cap N-rail Material: PA	Rail top cover
		Cable collector N-rail PA 4 cables Material: PA	Cable fixing
		Cable-tie clip for profile flange	Cable fixing
		Cable clip d = 10 mm	Cable fixing

\*\*\* Optionally available mounting system components e.g. for the visual enhancement of the system, cable laying or the earthing of the mounting system.

## 5 Installing the mounting system

Prior to mounting, the module field on the roof must be measured and the position of the fasteners (e.g. roof hooks, stock screws, saddle clamps etc.) defined taking into account the static calculation.

The individual mounting steps are described below for mounting modules in portrait mounting in the insertion system and clamping system. The various mounting versions (MV) can be found at the end of the respective mounting solution.

### 5.1 Roof hook mounting: insertion system

#### Expose rafters

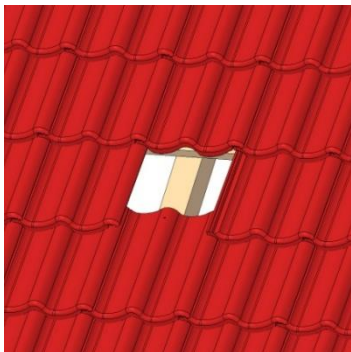

Expose the rafters by removing the tiles.

#### ⚠ WARNING

To execute the work a scaffold must have been installed in accordance with the relevant specifications.

#### Position roof hook

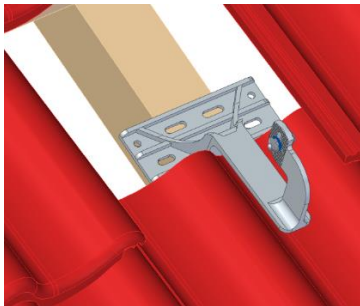

#### Version Roof hook ZD 633



Insert roof hook with the bracket positioned in the trough of the roof tile. Mark the top tile and, if necessary, the bottom tile at the roof hook exit point. If the distance to the tile cannot be maintained, either use additional support plates (optional component) or roof hooks ZD 633. For plain tile covering proceed according to MV 2 (clamping system mounting version).

#### Tile cut-out

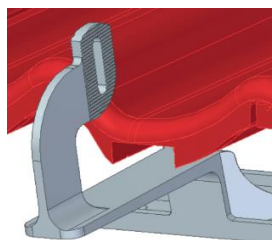

Interlocking tiles / concrete roof tile  
At the exit area of the roof hooks carefully make a cut-out with the angle grinder.

#### ⚠ WARNING

Observe accident prevention regulations, prevent material damage!

## Maintain gap

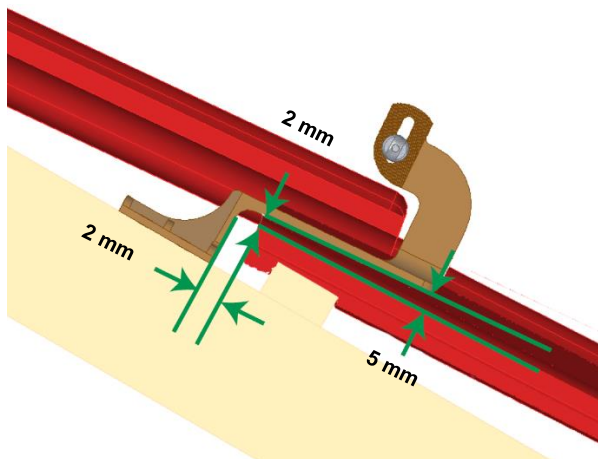

The minimum gaps between the bottom tile and support bracket must be adhered to. Align the roof hook to the centre of the rafter.

### NOTICE

If the gap is not observed, the bottom tile might be damaged under load.

## Attach roof hook

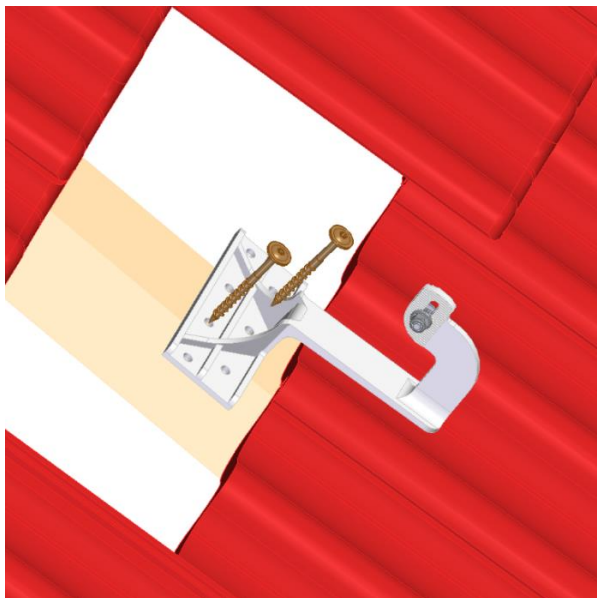

Attach the roof hooks to the rafter with wood screws. The screw length depends on the roof design and is determined by the calculation software. The wood screws must be screwed in without predrilling with the largest possible screw distance to each other whilst maintaining the edge distances to the rafter. If the counter battens were not taken into account during the dimensioning in the calculation software, the base profile of the roof hook must be padded on both sides of the counter batten for at least the width of the rafter.

### WARNING

Edge distances:

Screw  $d = 6 \text{ mm}$   $\rightarrow R = 18 \text{ mm}$

Screw  $d = 8 \text{ mm}$   $\rightarrow R = 24 \text{ mm}$

### NOTICE

The wood screws used in the system are approved by building authorities. If your own or non-equivalent screws are used, the system static becomes void.

## 5.2 Rail mounting: insertion system

### Mounting the rail

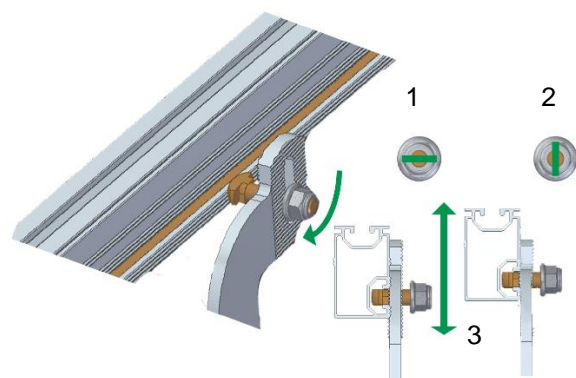

Place the N-rail near the slot next to the roof hook (1), rotate the screw head by  $90^\circ$  until the slot bolt is anchored in the groove (2), align the rail (3) to compensate for roof irregularities and to make the ribbing engage with each other, then tighten. The roof hook can also be connected to the rail connector in the joint area.

### NOTICE

Slot screw nut tightening torque 25 Nm, allow the rail to protrude beyond the mounting flange of the roof hook.

### Connect the rail

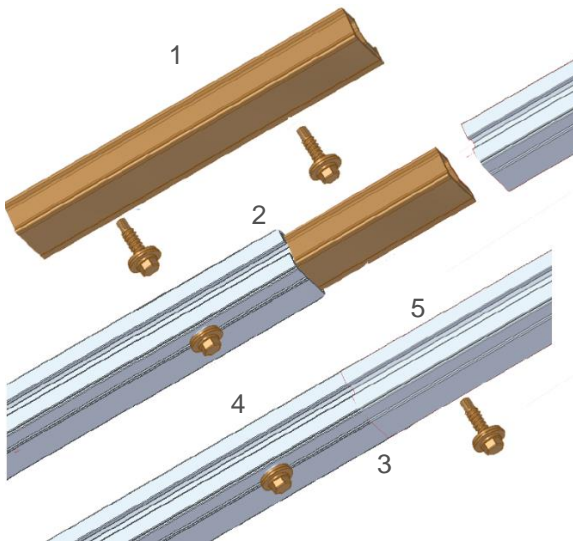

Push the connector (1) half way into one of the rails to be connected (2) and secure it there with a drilling screw in the lateral drilling groove. Next push the other rail completely onto the connector until both rail ends make contact (3) and also secure with a drilling screw. Maximum uninterrupted rail length 13 m, then install expansion joint.

N-rail L connector:  
secure additionally with two drilling screws at the corresponding points (4 and 5).

#### ⚠ WARNING

The accident prevention regulations must be complied with when cutting to size.

## 5.3 Module mounting: insertion system

### Mounting the Cross rail connector IR

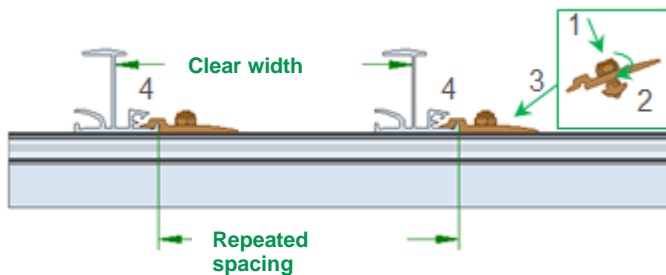

Insert the cross rail connector set N IR from above into the rail groove (1). Rotate the nut by 90° (2) and push the component against the insertion rail (3) until the cross rail connector set N IR engages with the mounting flange (4).

#### NOTICE

Cross rail connector set N IR tightening torque 25 Nm

Repeated spacing = module length L + 12 mm

Clear rail width = module length L + 10 mm

For mounting modules in landscape the module width instead of the module length must be used.

### Position of the Cross rail connector IR

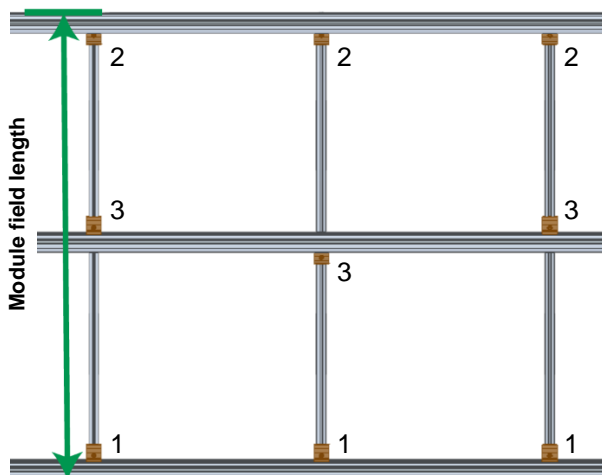

For the top and bottom insertion rail of the module field the cross rail connector IR is fitted on the inside in each case (1,2), at the centre insertion rails the fixing clamps must be fitted alternating at the top and the bottom at the mounting flange (3).

#### NOTICE

Module field length =

Repeated spacing x number of module fields + width of insertion rail

### Mounting Rail connector IR

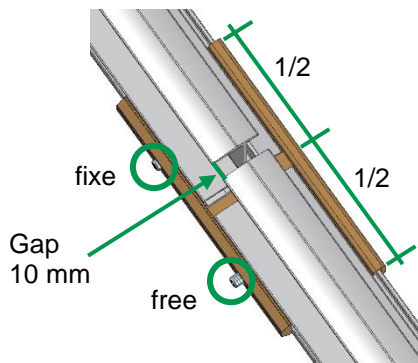

Centre the rail connector over the fitted rail and tighten the first threaded pin. Insert the rail to be connected into the connector, gap between the rails 10 mm, tighten the second threaded pin without play. MV 1 must be complied with for the mounting of the insertion rail Plus rails.

#### NOTICE

Do not fit connectors at the cantilever and above the drop rail. Threaded pin without play for longitudinal expansion.

### Module mounting: insertion system

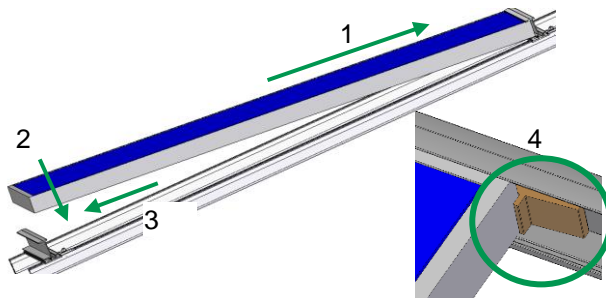

Place the module onto the top insertion rail and push it up (1). Then lower the module onto the bottom insertion rail (2) and push it down against the insertion rail (3). Mount the next modules following the same principle, the gap between the modules must be min. 3 mm.

#### NOTICE

Install the EPDM-T protection IR between the modules (4) with a module inclination <math>< 10^\circ</math> or as theft protection.

### Edge stop mounting

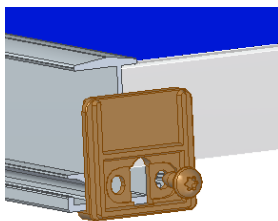

#### End cap for N-rail

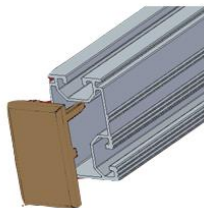

Fit an edge stop at the end of a module row at each insertion rail with a metal screw in the screw channel. For the insertion rail Plus use the matching edge stop (MV 1.4).

Seal the top and bottom ends of the N-rails with end caps.

#### NOTICE

The opening of the edge stop must expose the drainage channel of the insertion rail.

## 5.4 Insertion system mounting versions

### MV 1 Heavy snow loads

#### MV 1.1 Insertion Rail Plus mounting

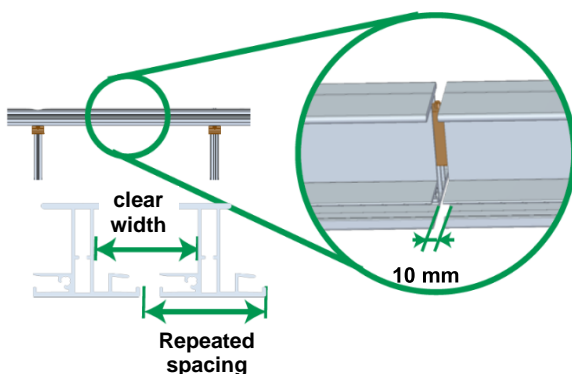

Attach the insertion rail Plus to the N-rails with Cross rail connector set N IR M8 as the insertion rail. Insert the connector for insertion rail Plus up to the stop and push the second rail with a distance of 10 mm over the rail connector.

#### NOTICE

Repeated spacing = module length L + 22 mm  
Clear rail width = module length L + 10 mm

### MV 1.2 Mounting the support rail IR

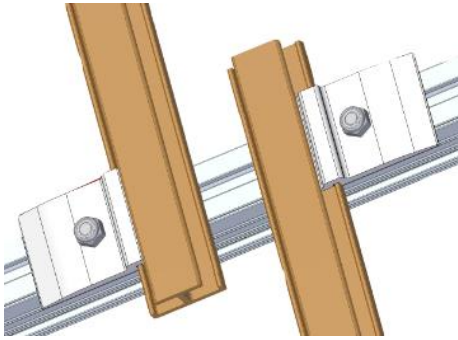

Attach the support rail IR with the Cross rail connector set N IR M8 - the support rails must be fitted parallel to the insertion rails and must be offset on the N-rail in the overlap area.

#### NOTICE

A 6.0 m long support rail must be attached with min. 3 Cross rail connector sets N IR M8

### MV 1.3 Distributing the round snow guard pipes

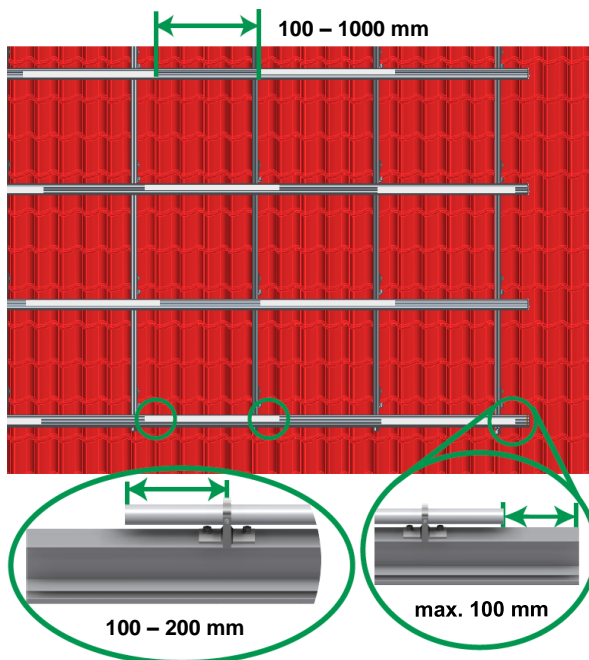

Distance between Aluminium round pipes at the end of the insertion rail in the corner area of the system max. 100 mm.  
Distance between round pipes min. 100 mm and max. 1000 mm.

For each 800 mm round pipe at least two brackets must be mounted at a distance of 100 – 200 mm from the end of the pipe.

The same mounting instructions apply to 6.0 m round pipes. Mounting distance of the brackets here is 500 – 600 mm each.

#### NOTICE

Arrange snow stop ES 20 x 5 aluminium round pipes per row of rails in a staggered arrangement, observing the minimum and maximum distances.

### MV 1.4 Attaching the bracket and mounting the edge stop

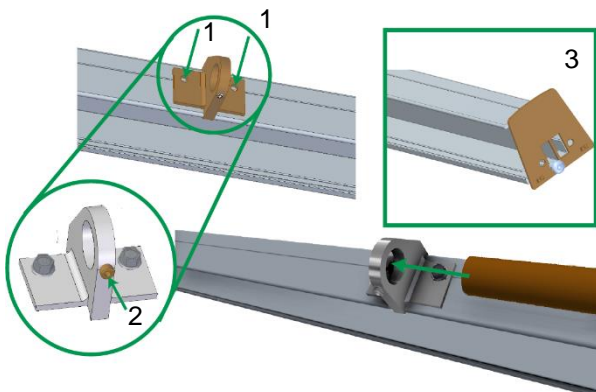

The brackets must be fitted with two drilling screws (1) to the insertion rail Plus. Position the rounded pipes centred and secure them with the grub screw (2).

Fit an edge stop at the end of a module row at each insertion rail with a metal screw in the screw channel (3).

#### NOTICE

If rounded pipes pass over a rail joint, only tighten one grub screw.  
The openings of the edge stop must expose the drainage channels of the insertion rail.

## 5.5 Roof hook mounting: clamping system

### Expose rafters

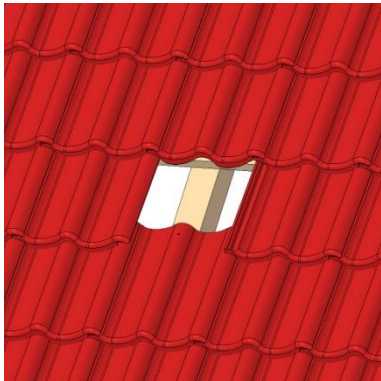

Expose the rafters by removing the tiles.

#### **⚠ WARNING**

To execute the work a scaffold must have been installed in accordance with the relevant specifications.

### Position roof hook

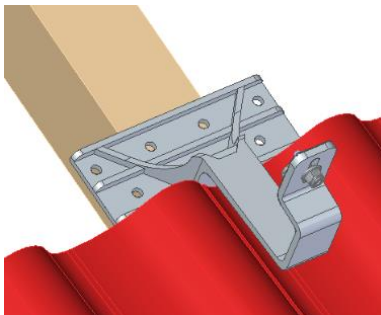

#### Plain tile version



Insert roof hook with the bracket positioned in the trough of the roof tile. Mark the top tile and, if necessary, the bottom tile at the roof hook exit point. If the distance to the tile cannot be maintained, use additional support plates (optional component). For plain tile covering follow the instructions in the clamping system mounting versions (MV 2).

### Tile cut-out

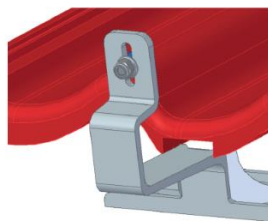

Interlocking tiles / concrete roof tile  
At the exit area of the roof hooks carefully make a cut-out with the angle grinder.

#### **⚠ WARNING**

Observe accident prevention regulations, prevent material damage!



### Maintain gap

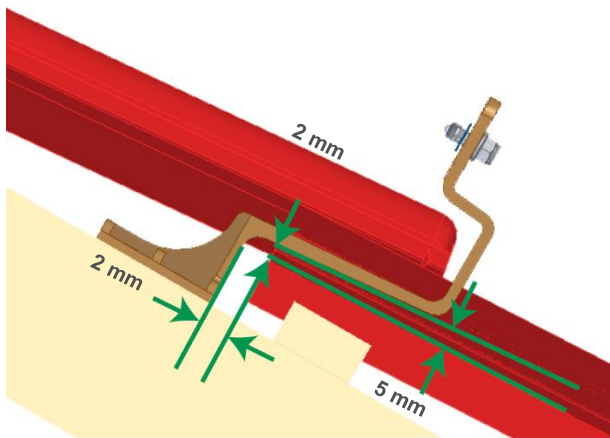

The minimum gaps between the bottom tile and support bracket must be adhered to. Align the roof hook to the centre of the rafter.

#### NOTICE

If the gap is not observed, the bottom tile might be damaged under load.

### Attach roof hook

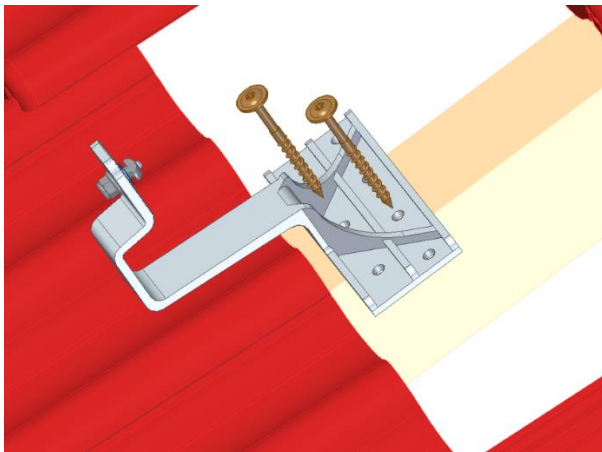

Attach the roof hooks to the rafter with wood screws. The screw length depends on the roof design and is determined by the calculation software. The wood screws must be screwed in without predrilling with the largest possible screw distance to each other whilst maintaining the edge distances to the rafter. If the roof hook is mounted on counter battens on the rafter or on rafter insulation, the base profile of the roof hook must be padded on both sides of the counter batten for at least the width of the rafter.

#### NOTICE

Edge distances:

Screw  $d = 6 \text{ mm}$   $\rightarrow R = 18 \text{ mm}$

Screw  $d = 8 \text{ mm}$   $\rightarrow R = 24 \text{ mm}$

#### WARNING

The wood screws used in the system are approved by building authorities. If your own or non-equivalent screws are used, the system static becomes void.

## 5.6 Rail mounting: clamping system

### Fit the horizontal rails

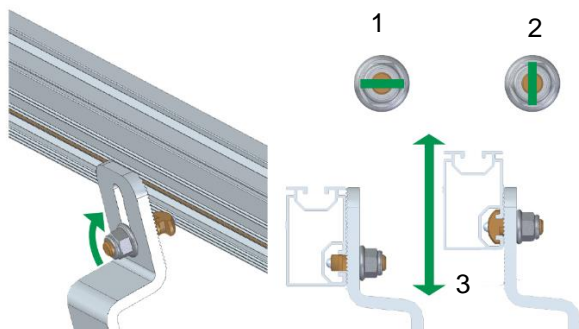

Place the N-rail near the slot against the roof hook (1). Rotate the screw head by  $90^\circ$  until the slot bolt is anchored in the groove (2). Align the rail (3) to compensate for roof irregularities and to make the ribbing engage with each other, then tighten. The roof hook can also be connected to the rail connector in the joint area. For mounting in the cross rail arrangement the top rail is attached using the Cross rail connector set N (MV 3).

#### NOTICE

Self-locking nut tightening torque 25 Nm. Allow the rail to protrude beyond the mounting flange of the roof hook.

### Connect the rails

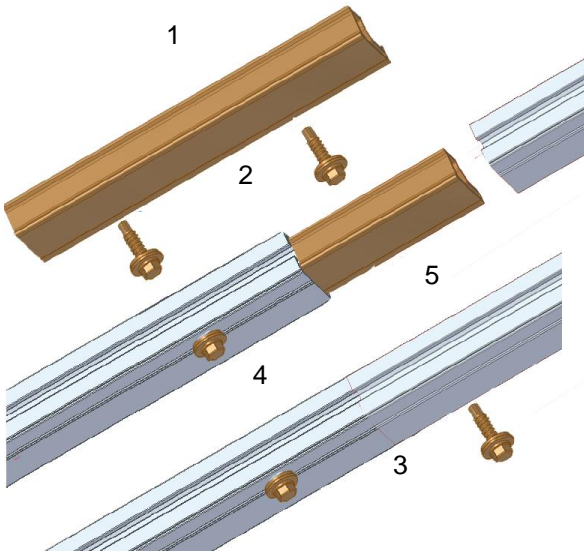

Push the connector (1) half way into one of the rails to be connected (2) and secure it there with a drilling screw in the lateral drilling groove. Next push the other rail completely onto the connector until both rail ends touch (3) and also secure with a drilling screw. Maximum uninterrupted rail length 13 m, then install expansion joint.

N-rail L connector:  
secure additionally with two drilling screws at the corresponding points (4 and 5).

#### **⚠ WARNING**

The accident prevention regulations must be complied with when cutting to size.

## 5.7 Module mounting: clamping system

### Module protection

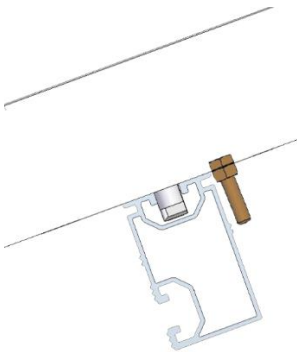

Prior to mounting the modules the module slip guard sets must be fitted to the frame holes above the bottom rail position (MV 4).

### Module clamping

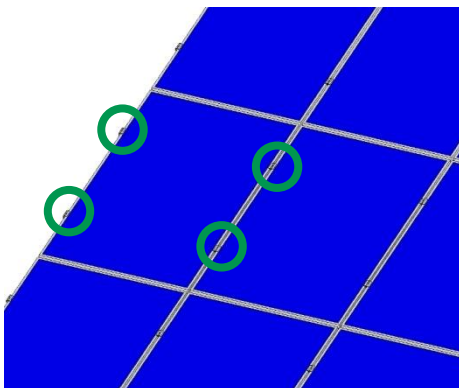

The modules must then be attached to the rails using end and middle clamps.

## Mounting the middle and end clamps

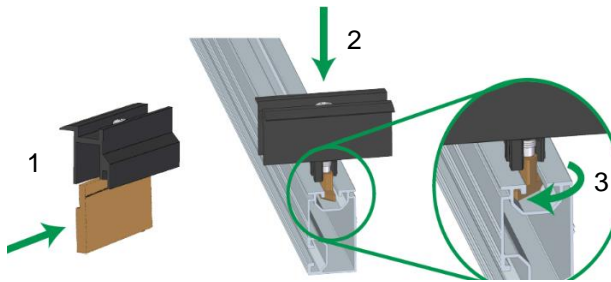

Fully assemble the end clamp, insert the spacer to do so (1). Place the module clamp onto the N-rail and press it on (2) until the slot nut engages with an audible “click” in the groove channel (3).

### NOTICE

During removal and re-installation rotate the slot nut back into the original position.

## Space requirement for middle and end clamps

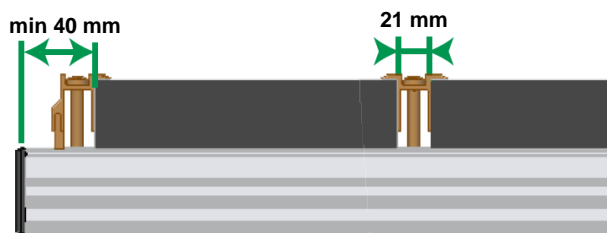

Ensure that the module clamps engage correctly in the rails. Push the modules all the way, then tighten the module clamps.

The end clamp can be fitted with a distance of 40 mm to the rail end.

### NOTICE

Module clamp tightening torque 15 Nm.

## 5.8 Clamping system mounting versions

### MV 2 Plain tile roof

#### MV 2.1 Mount plain tile sheet

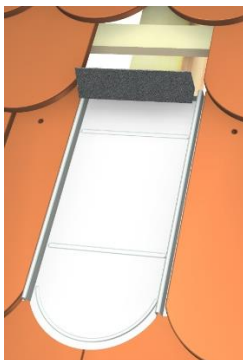

Determine the position of the sheet metal tile. Replace tile with plain tile sheet – the metal sheet edges are below the adjacent tiles – and secure with screws, then glue on foam wedge.

### ⚠ WARNING

Only glue foam wedges onto dry surfaces free from dust and grease.

### MV 2.2 Position plain tile roof hook

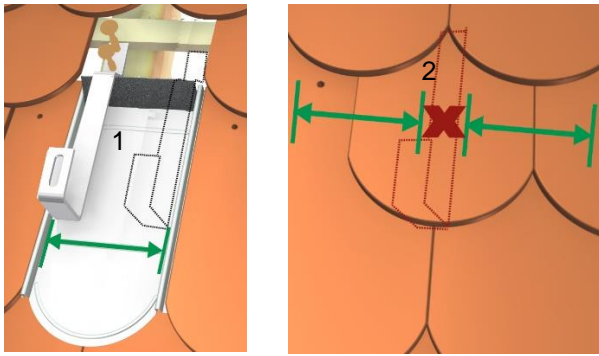

Align the roof hook in the centre of the rafter (1). Observe the permissible distances to the screws at the rafter edge. Do not place screw joints and support point at the locations of a joint (2). Screw in wood screw without predrilling.

#### ⚠ WARNING

The roof hooks are not approved as ascending aid or safety stop on the roof.

#### NOTICE

Edge distances:

Screw  $d = 6 \text{ mm} \rightarrow R = 18 \text{ mm}$

Screw  $d = 8 \text{ mm} \rightarrow R = 24 \text{ mm}$

### MV 2.3 Fit L adapter

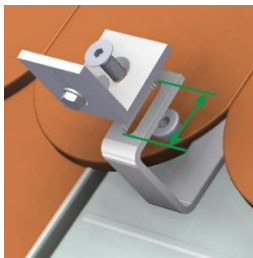

#### Version Drop rail mounting

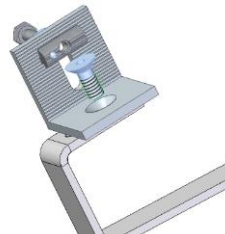

Secure the bracket in the slot of the roof hook, compensate for roof irregularities by changing the positioning of the bracket. For horizontal rail mounting rotate the bracket by 90°.

#### NOTICE

Countersunk screw tightening torque 40 Nm

### MV 2.4 Fit N-rail on L adapter

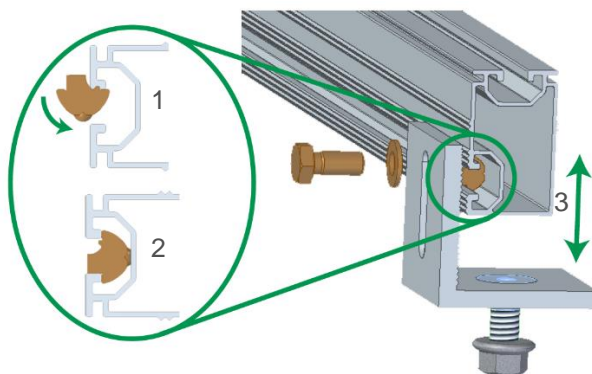

Position the slot nuts in the groove of the N-rail (1+2). Align the rail to compensate for roof irregularities (3) and to make the ribbing engage with each other, then tighten.

#### ⚠ WARNING

The rail end must always protrude laterally beyond the mounting flange of the roof hook. The module attachment is as described in "Module mounting - clamping system" or "Module mounting - insertion system".

#### NOTICE

Hexagon screw tightening torque 20 Nm

### MV 3 Mounting Cross rail connector N

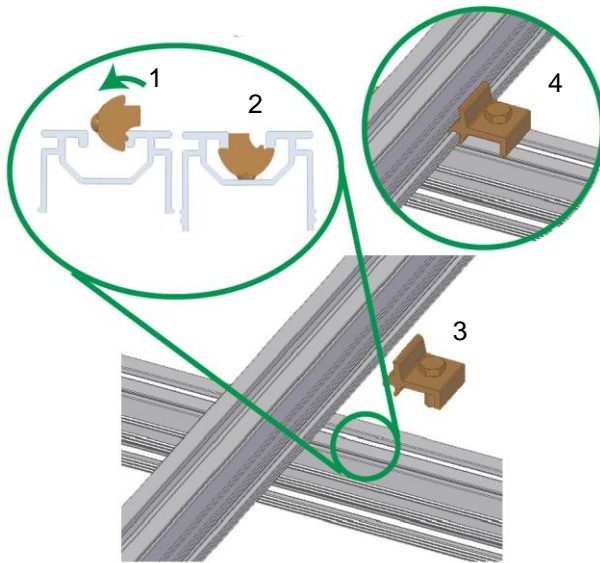

Insert the slot nut into the rail groove (1 and 2). Attach the fixing clamp with the screw (3) to the slot nut and push it against the upper rail (4) until the Cross rail connector set N M8 engages with the mounting flange.

The module attachment is as described in the section "Module mounting - clamping system".

#### **NOTICE**

Cross rail connector set N M8 tightening torque 22 Nm.  
Always attach to the side facing down.

### MV 4 Slip guard for box frame

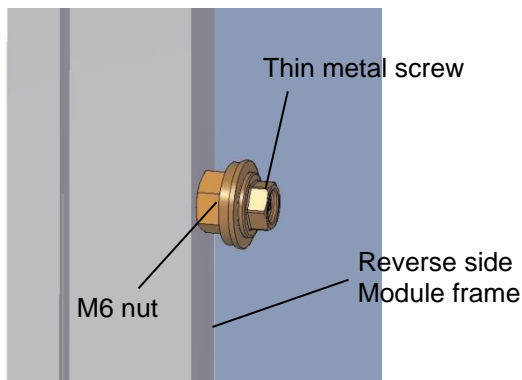

Push the nut over the screw and screw the thin metal screw into the module frame without predrilling.

#### **NOTICE**

The thin metal screw must not be overtightened.

## 6 Warranty / product liability (exclusion)

In addition to the above-mentioned regulations and safety notices the applicable regulations and rules of technology must be observed by the installing specialist company.

The installer is responsible for the dimensioning of the mounting system.

The installer is responsible for the connection of the interfaces between the mounting system and the building. This also includes the tightness of the building envelope.

For flat roofs the roof insulation must be evaluated by the installer on site within his own responsibility regarding the material of the sealing layer, resistance, ageing, compatibility with other materials, overall condition of the roof insulation, need for a separating layer between the roof insulation and the mounting system. The required and necessary measures or precautions for the protection of the roof insulation for the mounting of the substructure of a PV system must be initiated by the installer with the aid of a specialist tradesman where necessary. novotegra GmbH does not accept liability for faulty or inadequate measures and precautions for the protection of the roof insulation!

The installer must review the friction coefficient used in the calculation for the verification of the slip safety of PV systems on flat roofs on site. Friction coefficients determined on site can be taken into account by entering them in the Solar-Planit planning tool. novotegra GmbH does not guarantee the correctness of the assumed values and is not liable for damage due to the use of incorrect values.

The specifications of the module, cable and inverter manufacturers must be observed. If these contradict the mounting instructions, always consult the novotegra GmbH sales team before mounting the novotegra mounting system or – in the case of components not supplied by novotegra GmbH – the manufacturer concerned.

During the preparation of the offers for novotegra by our sales staff the local conditions are not always sufficiently known, which is why changes to the offered quantities may result during installation. These changes relate mainly to the number of fasteners for the building envelope (for example roof hooks). In this case the additionally required components must always be installed in accordance with the dimensioning.

novotegra GmbH is not liable for incorrect or incomplete data collection sheets. Error-free and fully completed data collection sheets are essential for correct dimensioning.

The information in the mounting instructions, the warranty terms and the information about the liability exclusion must be noted.



# novotegra

**novotegra GmbH**

Eisenbahnstraße 150  
72072 Tübingen | Deutschland

Tel. +49 7071 98987-0  
Fax +49 7071 98987-10

[info@novotegra.com](mailto:info@novotegra.com)  
[www.novotegra.com](http://www.novotegra.com)

