

PIKO CI

Solar inverter 30/50/60 kW

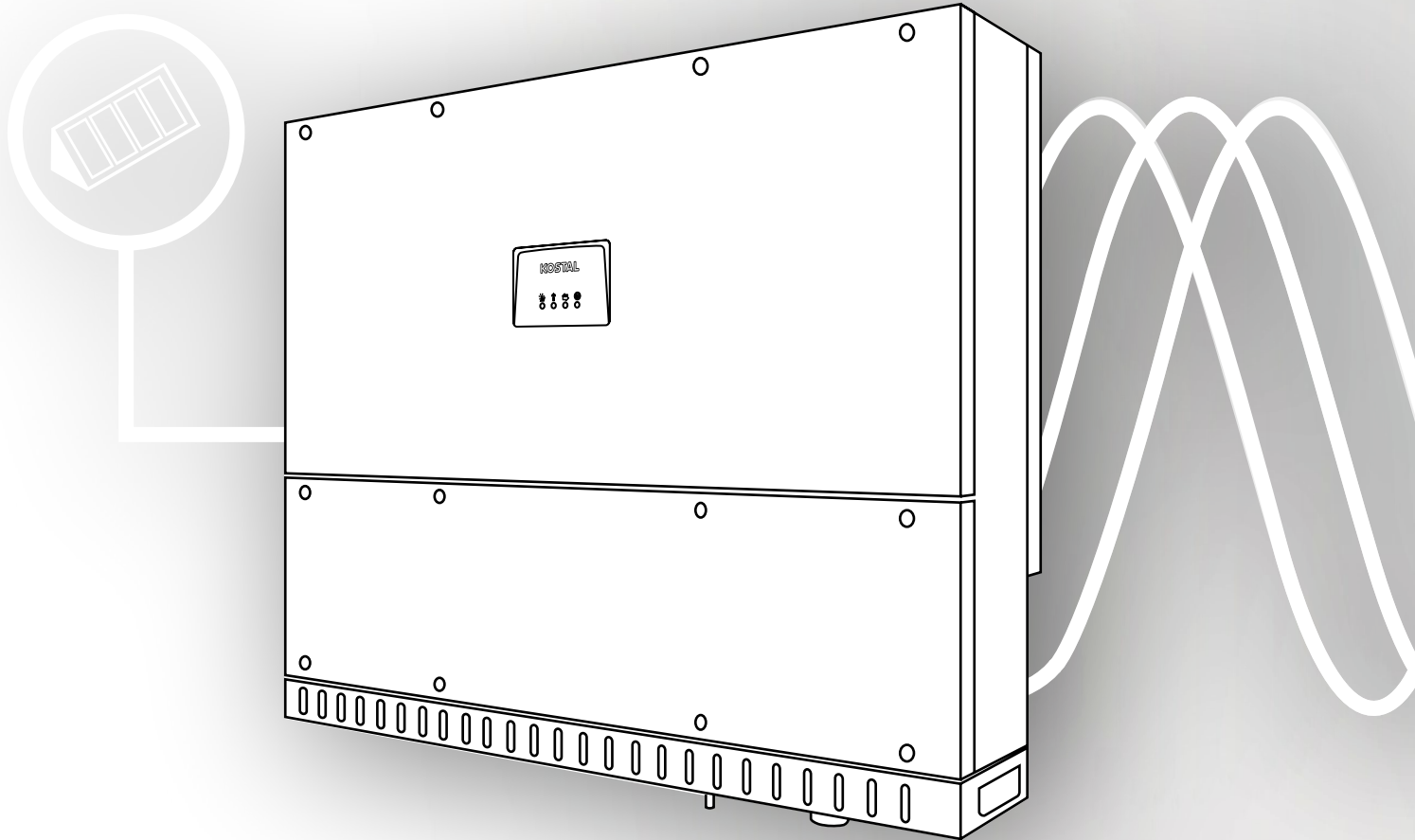

Smart connections.

Operating manual

Legal notice

KOSTAL Solar Electric GmbH
Hanferstraße 6
79108 Freiburg i. Br.
Germany
Phone +49 (0)761 477 44 - 100
Fax +49 (0)761 477 44 - 111
www.kostal-solar-electric.com

Exclusion of liability

All names, trademarks, product names or other designations used in this manual may be legally protected even if not indicated as such (e.g. as a trademark). KOSTAL Solar Electric GmbH assumes no liability or warranty for their free usage. The illustrations and texts have been compiled with great care. However, the possibility of errors cannot be ruled out. The compilation is made without any guarantee.

General note on gender equality

KOSTAL Solar Electric GmbH is aware of the importance of language with regard to the equality of women and men and always makes an effort to reflect this in the documentation. Nevertheless, for the sake of readability we are unable to use non-gender-specific terms throughout and use the masculine form instead.

© 2021 KOSTAL Solar Electric GmbH

All rights reserved by KOSTAL Solar Electric GmbH, including those of reproduction by photocopy and storage in electronic media. Commercial use or distribution of the texts, displayed models, diagrams and photographs appearing in this product is not permitted. This manual may not be reproduced, stored, transmitted or translated in any form or by means of any medium, in whole or in part, without prior written permission.

Valid from version:

Firmware (FW): V1.4.2

KOSTAL PIKO CI (app): V6.1.6

Thank you for choosing an inverter from KOSTAL Solar Electric GmbH.

You should have received all documentation about your PV system from your installer and have been informed about the following points:

- Position and function of all switching devices
- Safety when handling the device
- Professional approach to testing and maintenance
- Meaning of the LEDs
- Contact person in the event of a fault
- Optional system and test documentation according to DIN EN 62446 (VDE 0126-23)

If you have any technical questions, please call our service hotline:

- Germany and other countries¹
+49 (0)761 477 44 - 222
- Switzerland
+41 32 5800 225
- France, Belgium, Luxembourg
+33 16138 4117
- Greece
+30 2310 477 555
- Italy
+39 011 97 82 420
- Spain, Portugal²
+34 961 824 927

¹ Language: German, English

² Language: Spanish, English

Contents

1. General information	6
1.1 Proper use	7
1.2 EU declarations of conformity	9
1.3 About this manual	10
1.4 Notes in this manual	12
1.5 Symbols used	16
1.6 Labels on the device	17
2. Device and system description	18
2.1 System overview	19
2.2 Device overview	20
2.3 Functional overview	23
3. Installation	29
3.1 Transport and storage	30
3.2 Scope of delivery	31
3.3 Installation	32
3.4 Electrical connection	38
3.5 Overview of communication connections	43
3.6 Mounting WiFi antenna	44
3.7 Types of communication	45
3.8 Communication via LAN	47
3.9 Communication via RS485	49
3.10 Communication via WiFi	51
3.11 Connecting the KOSTAL Smart Energy Meter	52
3.12 Connecting central grid and system protection	61
3.13 Connecting the ripple control receiver	64
3.14 Closing the inverter	67
3.15 Connecting PV modules	68
3.16 Initial commissioning	73
4. Operation and operating the device	75
4.1 Switch on inverter	76
4.2 Switching off the inverter	77
4.3 De-energising the inverter	78
4.4 Inverter operating statuses	80
4.5 Status LEDs	81
4.6 Status display via app	83

5.	KOSTAL PIKO CI App	84
5.1	KOSTAL PIKO CI App	85
5.2	Installation of the KOSTAL PIKO CI app	86
5.3	Connecting inverters with KOSTAL PIKO CI app	87
5.4	Logging in as administrator	88
5.5	KOSTAL PIKO CI app - menu structure	89
5.6	KOSTAL PIKO CI app - menu description	93
6.	System monitoring	100
6.1	The log data	101
6.2	Interrogating log data	102
6.3	The KOSTAL Solar Portal	104
7.	Maintenance	105
7.1	During operation	106
7.2	Maintenance and cleaning	107
7.3	Housing cleaning	108
7.4	Fan	109
7.5	Replacing PV fuse	110
7.6	Updating software	111
7.7	Event codes	112
8.	Technical data	118
8.1	Technical data	119
8.2	Block diagrams	123
9.	Accessories	126
9.1	KOSTAL Solar Portal	127
9.2	KOSTAL Solar App	128
10.	Appendix	129
10.1	Type plate	130
10.2	Warranty and service	131
10.3	Handover to the operator	132
10.4	Decommissioning and disposal	133

1. General information

1.1	Proper use	7
1.2	EU declarations of conformity	9
1.3	About this manual	10
1.4	Notes in this manual	12
1.5	Symbols used	16
1.6	Labels on the device	17

1.1 Proper use

The inverter converts direct current from photovoltaic (PV) systems into alternating current. This can be used as follows:

- For self-consumption
- For feed-in into the public grid

The device may only be used in grid-connected systems within the intended power range and under the permissible ambient conditions. The device is not intended for mobile use.

Inappropriate use may lead to injury or even death for the user or third parties. Material damage to the device and other equipment can also occur. The inverter may therefore only be used for its intended purpose.

All components fitted on the inverter or in the system must satisfy the standards and guidelines that apply in the country of installation.

Exclusion of liability

Any use that differs from or goes beyond the stated intended purpose is considered inappropriate. The manufacturer accepts no liability for any damage resulting from this.

Modifications to the inverter are prohibited. The inverter may only be used if it is safe to operate and is in a technically perfect condition. Any instance of misuse will result in the termination of the warranty, guarantee and general liability of the manufacturer.

Only a qualified electrician may open the device. The inverter must be installed by a trained electrician (according to DIN VDE 1000-10 or BGV A3 accident prevention regulations or an internationally comparable standard) who is responsible for observing the applicable standards and regulations.

Work that could affect the electrical power system of the relevant energy supply company may only be carried out by qualified electricians expressly authorised (licensed) by the energy supply company. This includes changes to the factory-preset parameters. The installer must always observe the regulations of the energy supply company.

Factory settings may only be changed by qualified electrical installers or persons with at least comparable or higher technical qualifications, e.g. foremen, technicians or engineers. When doing so, all requirements are to be observed.



IMPORTANT INFORMATION

The inverter may only be installed, maintained and repaired by a trained and qualified electrician.

The electrician is responsible for ensuring that the applicable standards and regulations are observed and implemented. Work that could affect the electrical power system of the relevant energy supply company at the site of the solar power feed-in, may only be carried out by qualified electricians expressly authorised (licensed) by the energy supply company.

This includes changes to the factory-preset parameters.

1.2 EU declarations of conformity

KOSTAL Solar Electric GmbH declares that the inverter described in this document complies with the basic requirements and other relevant conditions of the directives listed below.

- Directive 2014/30/EU
(on the approximation of the laws of the Member States relating to electromagnetic compatibility (EMC))
- Directive 2014/35/EU
(on the harmonisation of the laws of the Member States relating to the making available on the market of electrical equipment designed for use within certain voltage limits – in short: Low Voltage Directive)
- Directive 2015/53/EU
(provision of radio equipment - in short: Radio Equipment Directive, RED)
- Directive 2011/65/EU
(restriction of the use of certain hazardous substances in electrical and electronic equipment, RoHS)

You will find a detailed EU Declaration of Conformity in the download area at:

www.kostal-solar-electric.com

1.3 About this manual

Read this manual carefully in its entirety.

It contains important information on the installation and operation of the inverter. Pay particular attention to the instructions regarding safe usage. KOSTAL Solar Electric GmbH assumes no liability for damages arising from the non-observance of this manual.

This manual is an integral part of the product. It applies exclusively to the inverters from KOSTAL Solar Electric GmbH. Keep this manual and give it to the new owner should you pass it onto a new operator.

The installer and the operator must have unrestricted access to these instructions at all times. The installer must be familiar with this manual and follow all instructions.

The current version of the operating manual for your product is available in the download area at www.kostal-solar-electric.com.

Target group

This manual is intended for trained and qualified electrical technicians who install, maintain and repair the inverters.

The inverters described in this manual differ from one another in terms of particular technical details. Information and handling instructions that only apply to certain device types, are to be identified accordingly.

Information concerning your safety or that of the unit is specifically noted.

Navigation through the document

To simplify navigation through this document, it contains clickable areas.

One of these is the navigation bar in the header of each page. By clicking here, you are taken to the overview pages of the individual chapters.

The table of contents can also be used in this way: From the index at the beginning of each chapter you can go to the indicated sub-chapter in one click.

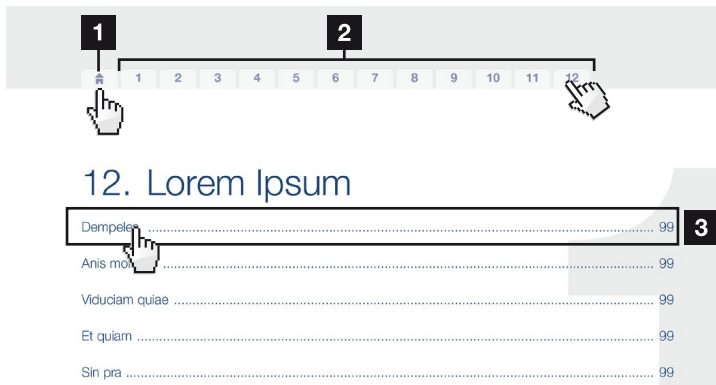

Fig. 1: Navigation through the document

- 1** Calling up the main table of contents
- 2** Navigation bar
- 3** Tables of contents

You can navigate to the referenced points in the document within the instruction text using the cross-references.

- 📄 Ch. 1**
- 📄 Fig. 1, It. 2**

Fig. 2: Examples of cross-references

1.4 Notes in this manual

Notes have been incorporated into the instruction text. A differentiation is made in this manual between warnings and information notes. All notes are identified in the text line by an icon.

The diagram illustrates how safety notes are integrated into the instruction text. It shows three examples of notes within the text, each with a callout icon (1) pointing to a larger, detailed version of that note (2, 3, or 4).

Installation  1

Install a line circuit breaker into the mains cable between the inverter and the feed meter to secure it against overcurrent.

In countries in which a second PE connection is prescribed, connect this at the marked place on the housing.

Connecting AC-side  1

Connect the wires of the mains cable to the AC terminal in accordance with the labelling.

For connection with a computer or with a computer network. Connect several inverters to a network for data retrieval.  1

DANGER  2

Risk of death due to electrical shock and discharge!
De-energise the device, secure it against being restarted and wait five minutes so that the capacitors can discharge.

IMPORTANT NOTE  3

To connect the AC cables, the inverter is equipped with spring-loaded terminal strips.

INFO  4

For connection with a computer, an Ethernet cable of category 6 is to be used.

Fig. 3: Safety instructions in this manual

- 1 Note icon within the instruction text
- 2 Warning
- 3 Information note
- 4 Other notes

Warnings

Warnings refer to life-threatening dangers. Serious injuries possibly resulting in death may occur.

Each warning consists of the following elements:

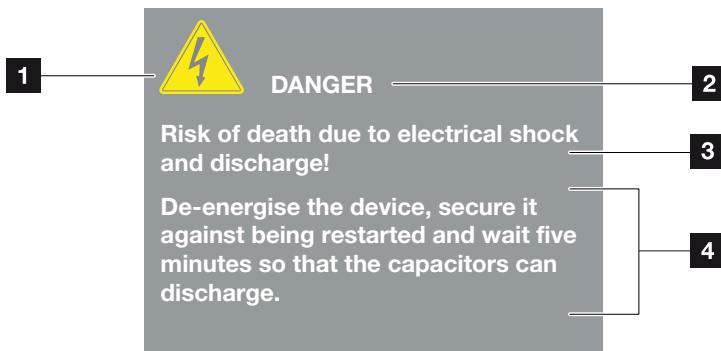

Fig. 4: Structure of the warnings

- 1** Warning symbol
- 2** Signal word
- 3** Type of danger
- 4** Corrective actions

Warning symbols



Danger



Danger due to electrical shock and discharge



Danger due to burns

Signal words

Signal words are used to identify the severity of the danger.

DANGER

Indicates a direct hazard with a high level of risk, which may result in death or serious injury if it is not prevented.

WARNING

Indicates a hazard with a moderate level of risk, which may result in death or serious injury if it is not prevented.

CAUTION

Indicates a hazard with a low level of risk, which may result in minor or slight injury or property damage if it is not prevented.

Information notes

Information notes contain important instructions for the installation and problem-free operation of the inverter. These must be followed at all times. The information notes also point out that failure to observe instructions may result in damage to property or financial damages.

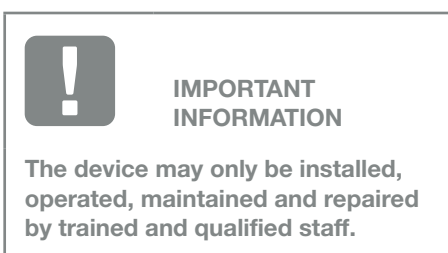

Fig. 5: Example of an information note

Symbols within the information notes



Important information



Damage to property possible

Other notes

They contain additional information or tips.



INFO

This is additional information.

Fig. 6: Example of an information note

Symbols within the additional notes



Information or tip



Enlarged view

1.5 Symbols used

Symbol	Meaning
1., 2., 3. ...	Sequential steps in a handling instruction
→	Effect of a handling instruction
✓	Final result of a handling instruction
↗	Cross-reference to other places in the document or to other documents
■	List

Tab. 1: Symbols and icons used

Abbreviations used

Abbrevia- tion	Explanation
Tab.	Table
Fig.	Figure
It.	Item
Ch.	Chapter

1.6 Labels on the device

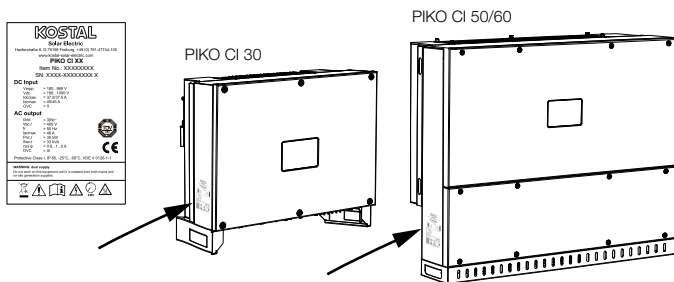

The type plate and other labels are attached to the inverter housing. These signs and labels may not be altered or removed.

Symbol	Explanation
	Danger due to electrical shock and discharge
	Danger due to burns
	Danger notice
	Danger due to electrical shock and discharge. Wait five minutes (discharge time of the capacitors) after shut-down
	Additional earth connection
	Observe and read operating manual
	Device may not be disposed of with household waste. Observe the local application of disposal requirements
	CE marking The product satisfies the applicable EU requirements

2. Device and system description

2.1	System overview	19
2.2	Device overview	20
2.3	Functional overview	23

2.1 System overview

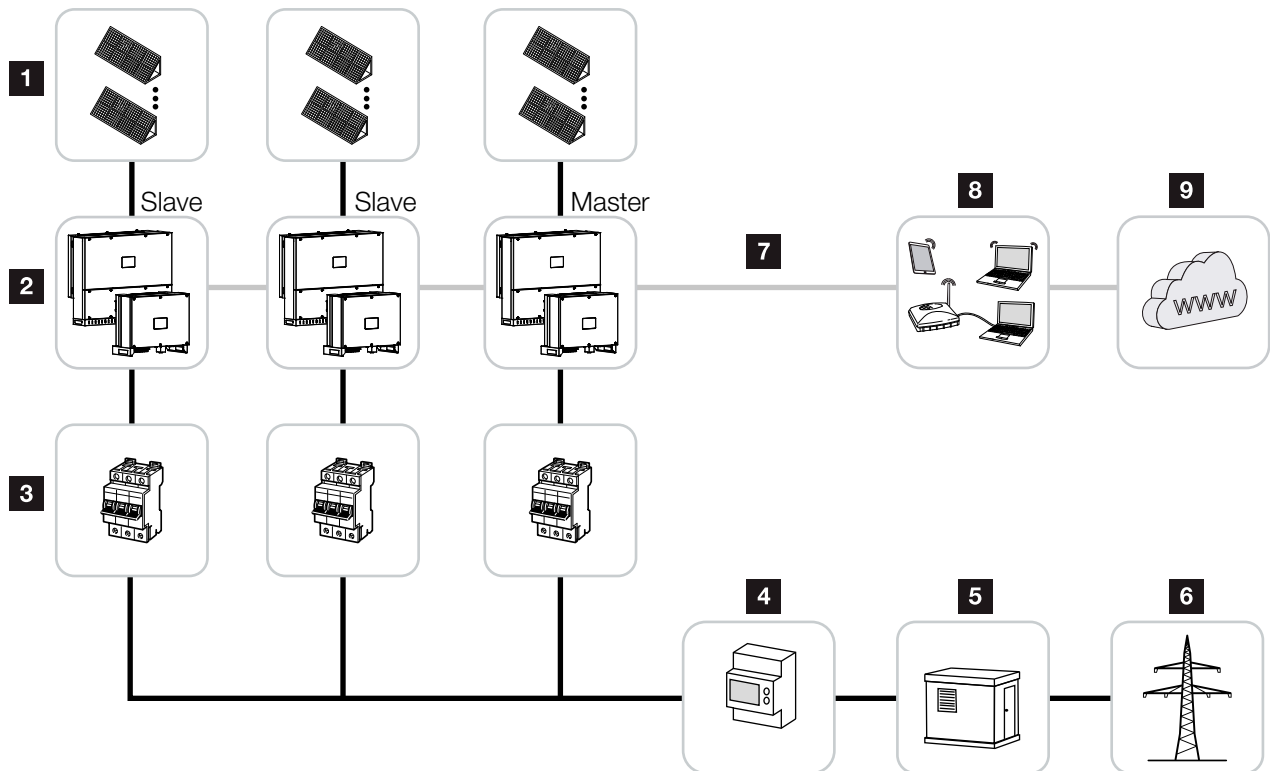

Fig. 7: System overview

- 1 PV strings
- 2 PIKO CI 30 / 50 or 60 inverter
- 3 AC line circuit breaker
- 4 Energy meter
- 5 Distributor
- 6 Public grid
- 7 Communication connection (optional)
- 8 Router, PC connection
- 9 Internet

2.2 Device overview

PIKO CI 30 inverter

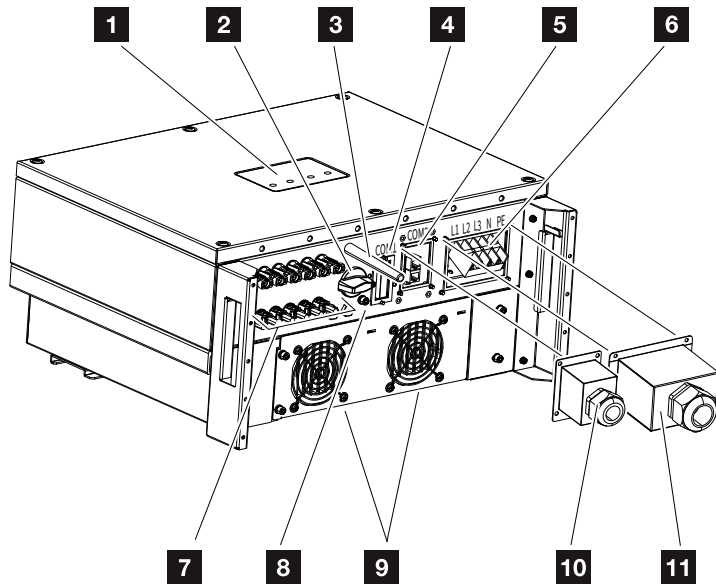

Fig. 8: PIKO CI 30 inverter (exterior view)

- 1** Status LED
- 2** DC switch
- 3** WiFi antenna
- 4** COM1 connection panel (communication module)
- 5** COM2 connection panel (RS485, LAN, digital inputs)
- 6** Connection for mains cable
- 7** Connections for PV modules
- 8** Additional PE connection (outside)
- 9** Fan
- 10** Cover for COM2 connection panel
- 11** Cover for grid connection

PIKO CI 50/60 inverter

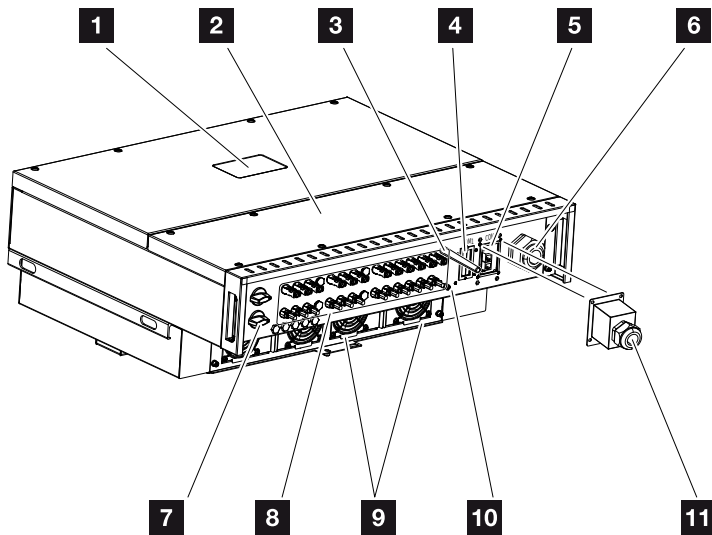

Fig. 9: PIKO CI 50/60 inverter (exterior view)

- 1** Status LED
- 2** Cover for terminal compartment
- 3** WiFi antenna
- 4** COM1 connection panel (communication module)
- 5** COM2 connection panel (RS485, LAN, digital inputs)
- 6** Cable opening for mains cable
- 7** DC switch
- 8** Connections for PV modules
- 9** Fan
- 10** Additional PE connection (outside)
- 11** Cover for COM2 connection panel

Status LED

The status LED provides information about the operating status of the inverter.

Further information on this subject [↗ Ch. 4.5](#).

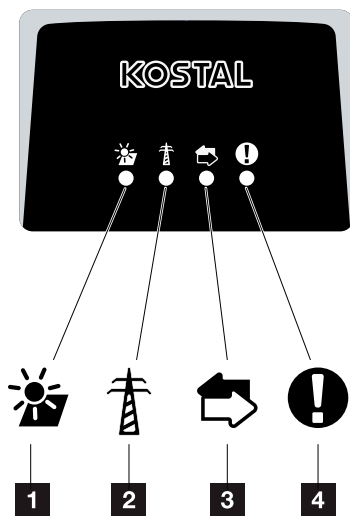

Fig. 10: Status LED

- 1** Status of PV modules
- 2** Status of grid
- 3** Status of communication
- 4** Warning message

2.3 Functional overview

The inverter converts energy from the connected PV modules into alternating current and feeds this into the public grid.

Three-phase alternating current

The PIKO CI inverters generate three-phase alternating current and, with their high output power, are optimised for use in medium and large PV systems. This makes them suitable for solar power plants, electricity farms and similar applications. The inverters can be operated in TT, TN-C, TN-S and TN-C-S grids.

Wireless commissioning

Commissioning is undertaken wirelessly using tablets or smartphones. The **KOSTAL PIKO CI** app is available for this purpose, which you can download free of charge from the App Store.

Recording power generation

By connecting an external energy meter, the inverter can monitor the energy flow and optimally control the output power according to grid requirements.

Communication

The inverter has various interfaces for communication purposes. These establish a connection to other inverters, sensors, energy meters or a link to the Internet.

- RS485/Modbus (RTU)
Data loggers or energy meters are connected to the Modbus interface to record the energy flow.
- LAN or WiFi can be used to connect the inverter to the local network via which it can then access the Internet and solar portal.

All data is transmitted encrypted.

Central grid and system protection

A remote connection enables connection to a circuit breaker and thus the implementation of central grid and system protection as required by technical regulations of the grid operators.

Ripple control receiver

For systems in which the grid operator controls the feed-in capacity using ripple control receivers, the inverter has the required digital inputs.

App functions

The **KOSTAL PIKO CI** app, which is available free of charge, provides a graphical user interface. The app is used to commission and configure the inverter and to display its status:

- Log in on inverter
- Log in as user or administrator
- Status request
- Current feed-in values at grid connection
- Display log data / events
- Inverter version display
- Inverter configuration
(e.g. LAN connection, setting up the energy meter, etc.)

KOSTAL Solar Portal

The **KOSTAL Solar Portal** protects your investment in a PV system against yield loss, e.g. through active e-mail alerts of events.

You can sign up for a free user account on the **KOSTAL Solar Portal** at www.kostal-solar-portal.com.

Functions include:

- Worldwide online access to the portal
- Graphic representation of the power and yield data
- Visualisation of data and thus being made aware of how to optimise self-consumption
- Notification of events by e-mail
- Data export
- Sensor evaluation
- Display and proof of a potential active power reduction by the grid operator
- Storage of log data for long-term and reliable monitoring of your PV system
- Provision of system data for the KOSTAL Solar App

Additional information about this product is available on our website www.kostal-solar-electric.com under **Products > Monitoring software > KOSTAL Solar Portal**.

Event codes

Events or faults during operation are stored in the inverter's event memory and transmitted to the **KOSTAL Solar Portal** or can be queried via the **KOSTAL PIKO CI** app.

For more information  **Ch. 7.7**.

Service concept

The event codes can be read out via the **KOSTAL PIKO CI** app or **KOSTAL Solar Portal** when servicing is required. Your installer or service partner can then decide what action to take before on-site deployment. In this way, multiple on-site deployment can be avoided.

KOSTAL Solar Plan configuration software

Our free **KOSTAL Solar Plan** software simplifies the inverter layout process.

Just enter the system data and individual customer data and receive a recommendation for a KOSTAL inverter tailored to the solar system you're planning. All KOSTAL inverters are included. The customer's power consumption is also considered and, using standard load profiles, the potential for self-consumption and self-sufficiency is indicated.

The **KOSTAL Solar Plan** covers the following areas of inverter layout:

- Rapid layout
Manual inverter layout taking account of the inverter specifications
- Layout
Automatic inverter layout with the option of taking power consumption into account
- Storage layout
Automatic inverter layout with the option of taking power consumption into account

Alongside enhanced inverter layout, **KOSTAL Solar Plan** also helps you to produce quotations. Customer, project and installer data is added to the technical data entered by the user, then included with the quotation as a PDF overview. What's more, the planning data can also be saved in a project file and edited if required.

You can find additional information about this product on our website www.kostal-solar-electric.com under **Installer portal > KOSTAL Solar Plan**.

3. Installation

3.1	Transport and storage	30
3.2	Scope of delivery	31
3.3	Installation	32
3.4	Electrical connection	38
3.5	Overview of communication connections	43
3.6	Mounting WiFi antenna	44
3.7	Types of communication	45
3.8	Communication via LAN	47
3.9	Communication via RS485	49
3.10	Communication via WiFi	51
3.11	Connecting the KOSTAL Smart Energy Meter	52
3.12	Connecting central grid and system protection	61
3.13	Connecting the ripple control receiver	64
3.14	Closing the inverter	67
3.15	Connecting PV modules	68
3.16	Initial commissioning	73

3.1 Transport and storage

The function of the inverter has been tested and it has been carefully packaged prior to delivery. Upon receipt, check the delivery for completeness and any transport damage. 📦

- Store all components of the inverter in the original packaging in a dry and dust-free place if the inverter is to be stored for a longer period of time before installation.
- Replace the packing material if it has been damaged.
- Do not stack more than four inverters on top of each other.

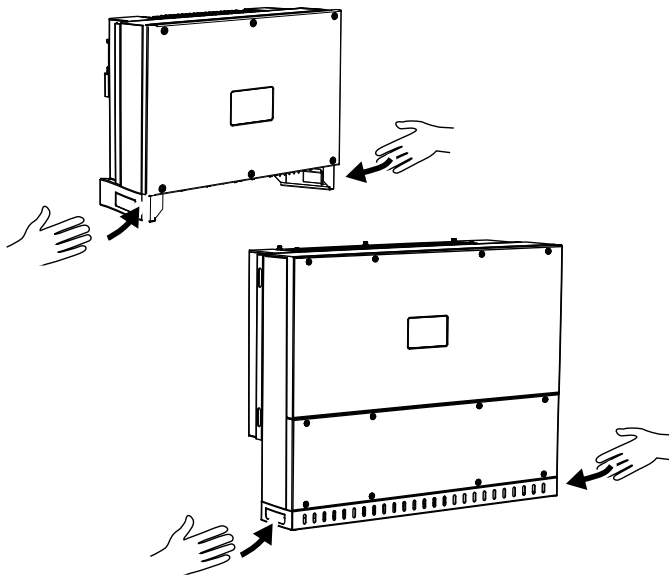

- To transport the inverter, use the recessed grips on the left and right of the bottom. ⚠️
- Do not tip the inverter onto its side. Avoid tilted positions.
- Only place the inverter down on its back.
- Do not place the inverter down on its side or on the top.



DAMAGE POSSIBLE

Potential risk of damage when putting down the inverter. Whenever possible, place the inverter on its back after unpacking.

Complaints and claims for damages should be addressed directly to your freight company.



CAUTION!

Danger of injury! The inverter is very heavy. Do not lift or transport the inverter alone. Involve at least one or two other persons to avoid injury.

3.2 Scope of delivery

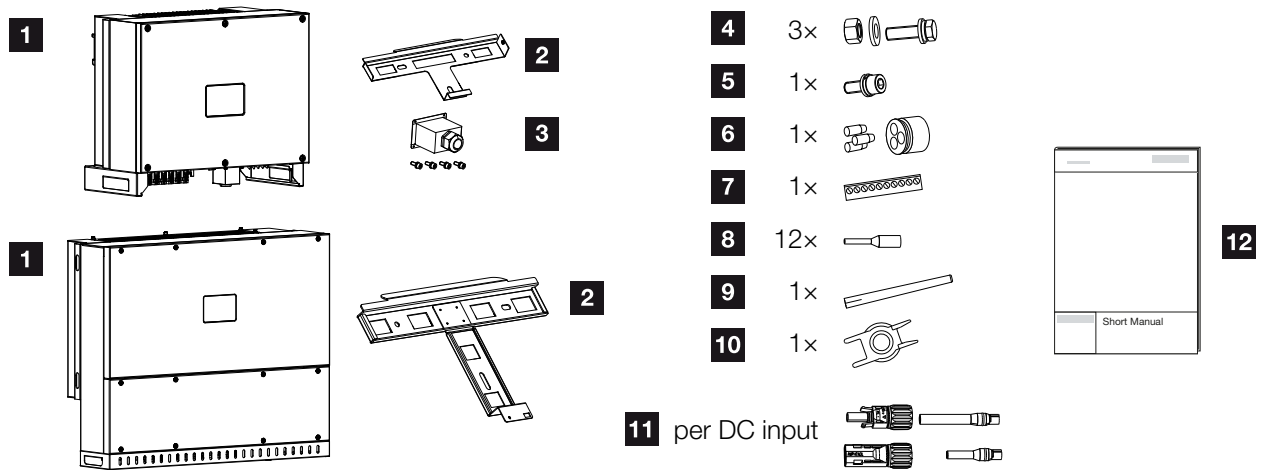

Fig. 11: Scope of delivery

- 1** Inverter
- 2** Wall mount
- 3** Cover for AC connection
- 4** Mounting kit: 3× M12 screws with nut and washer
- 5** Locking screw M6 (1×)
- 6** Plug seals for routing communication cables with 3 plugs
- 7** Plug connector for communication interface
- 8** 12 x core end sleeves for communication cables
- 9** WiFi antenna
- 10** Removal tool for DC plug connectors
- 11** DC plug connector
(each DC input: 1× plug, socket)
- 12** Short manual

3.3 Installation

Selecting the installation site



Install the inverter indoors.



Install the inverter in a protected outdoor area.



Protect the inverter from direct precipitation.



Protect the inverter from coarse soiling, e.g. leaves.

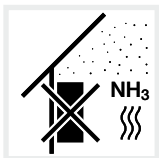

Protect the inverter from dust, contamination and ammonia gases. Do not install in rooms and areas where animals are kept.



Do not install the inverter in potentially explosive areas.

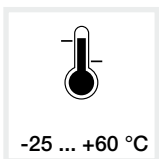

The ambient temperature must be between -25 °C and +60 °C.



IMPORTANT INFORMATION

Observe these instructions when selecting the installation site. Failure to observe these instructions may limit guarantee claims or render them fully null and void.

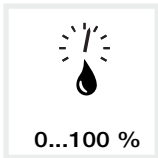

The air humidity can be between 0 % and 100 % (condensing).

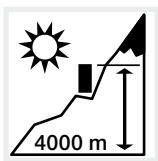

Inverter may only be installed up to an altitude of 4000 m.

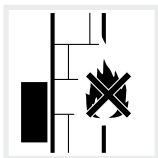

A sufficient safety distance from flammable materials and potentially explosive areas in the vicinity must be ensured.

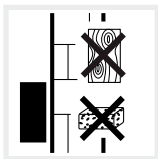

Install inverter on a stable installation surface that can safely bear the weight. Plasterboard walls and wood planking are not permitted.

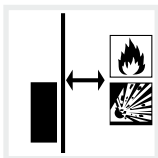

Do not install the inverter on a flammable installation surface. 

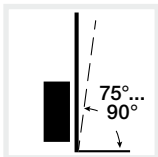

Install the inverter vertically. Tilted position up to 15° is permitted.

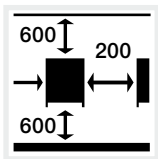

Maintain minimum distances and the necessary clearance.



WARNING

RISK OF BURNS FROM HOT PARTS ON THE INVERTER!

Some of the inverter components can reach temperatures of over 80 °C during operation. Select the installation site in accordance with the information provided in these instructions. Always keep the ventilation openings clear.



The inverter makes noise during operation. Install inverter in such a way that people are not disturbed by operation noises.

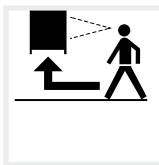

The inverter must be easily accessible and the status LED must be easy to read.



Install the inverter out of reach of children or other unauthorised persons.



Lay cables with UV protection or use UV-resistant cables.

Installation dimensions

For installation, use retaining bolts that are suitable for the base, the weight of the inverter and the ambient conditions.

Requirement of retaining bolts:
 Ø 12 mm, 8.8, A2-70



IMPORTANT INFORMATION

Be absolutely sure to maintain the clearance around the inverter in order that the inverter remains cool.

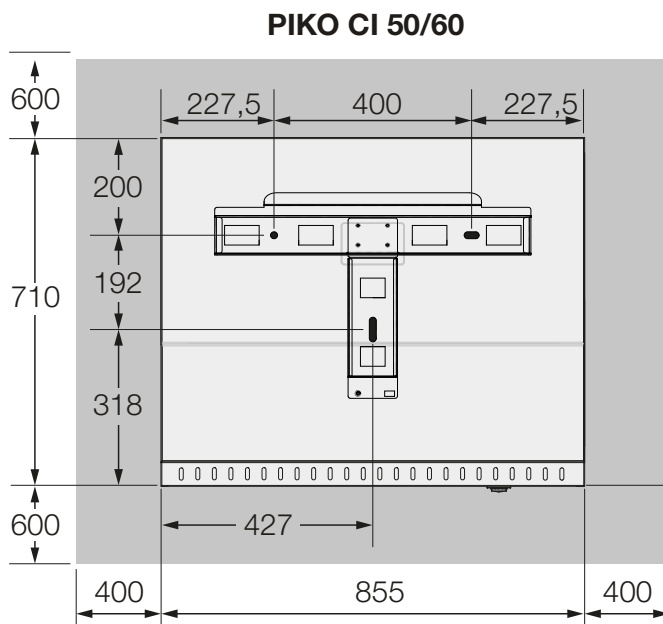
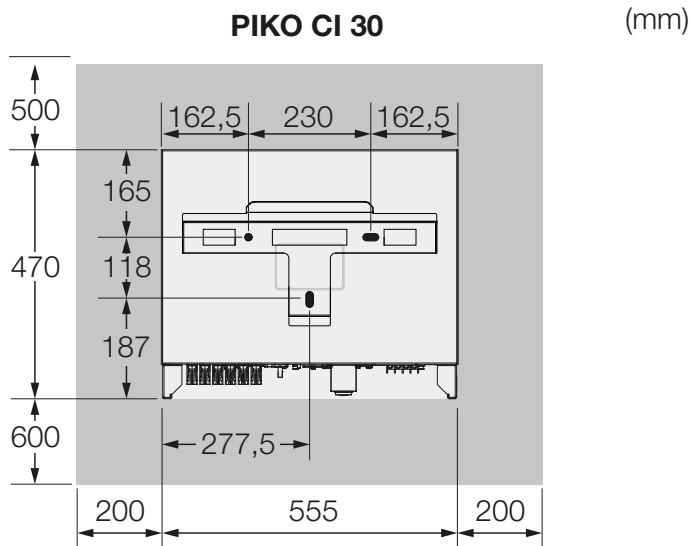
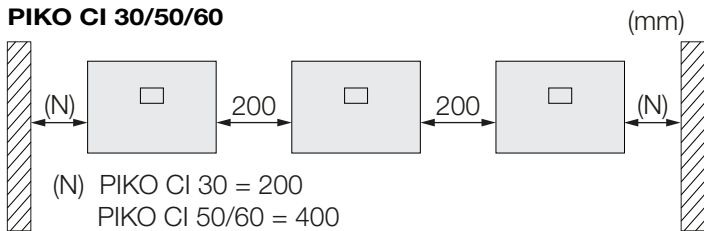

Fig. 12: Installation dimensions with bracket

Distances between inverters 

PIKO CI 30/50/60



PIKO CI 30

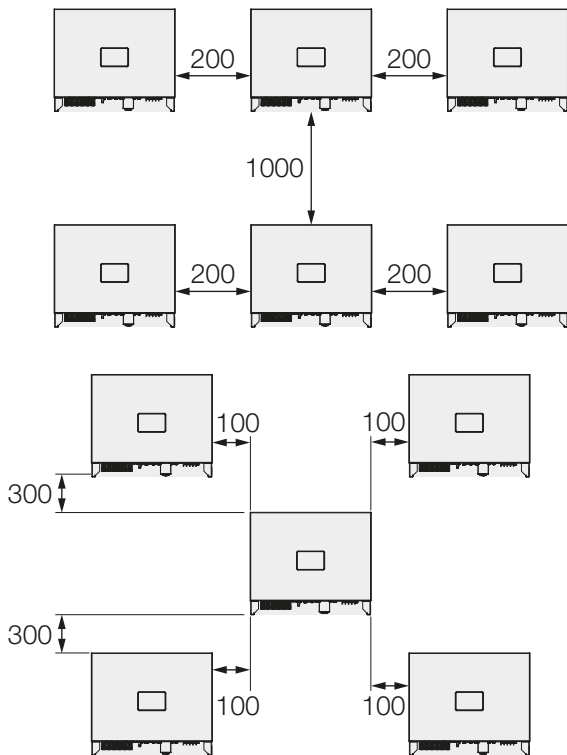

PIKO CI 50/60

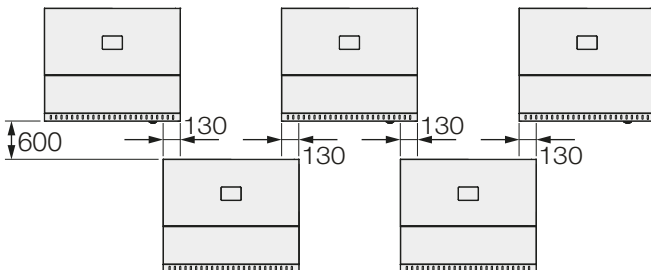

Fig. 13: Several inverters side by side



IMPORTANT INFORMATION

The values given are minimum distances. Increase the distances if the thermal conditions in the installation environment require it, e.g. in case of unfavourable ventilation or strong sunlight.

Installing the inverter

PIKO CI 30:

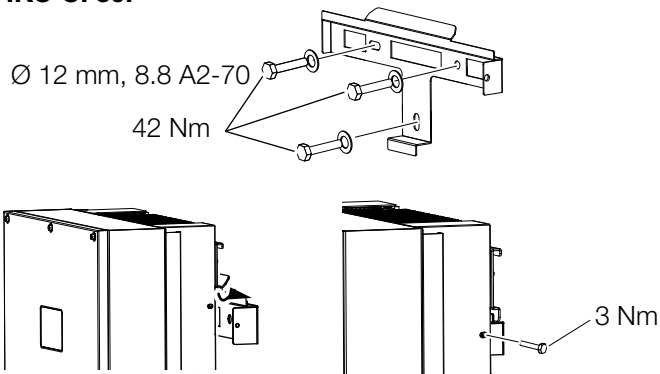

PIKO CI 50/60:

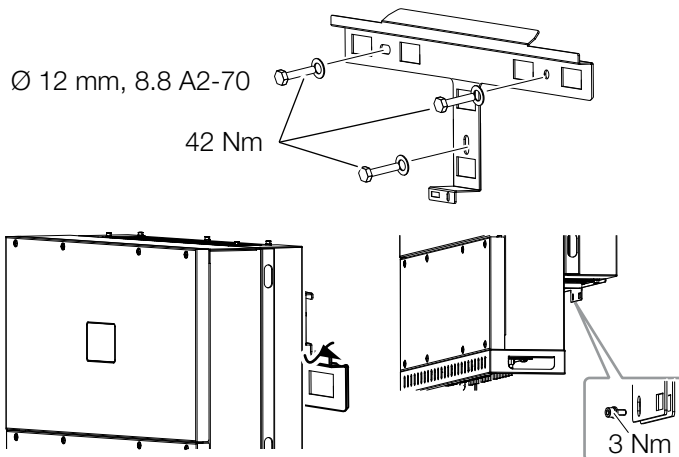



Fig. 14: Installing the PIKO CI inverter

- Install the inverter on a solid wall or on a stand. Observe the prescribed distances and other specifications.
- Install the bracket on the base.
- Lift the inverter onto the bracket .
- Make sure that the inverter is correctly seated and cannot slip off the bracket.
- Install the lock screw.



CAUTION!

Danger of injury! The inverter is very heavy. Do not lift or transport the inverter alone. Involve at least one or two other persons to avoid injury.

3.4 Electrical connection

Overview

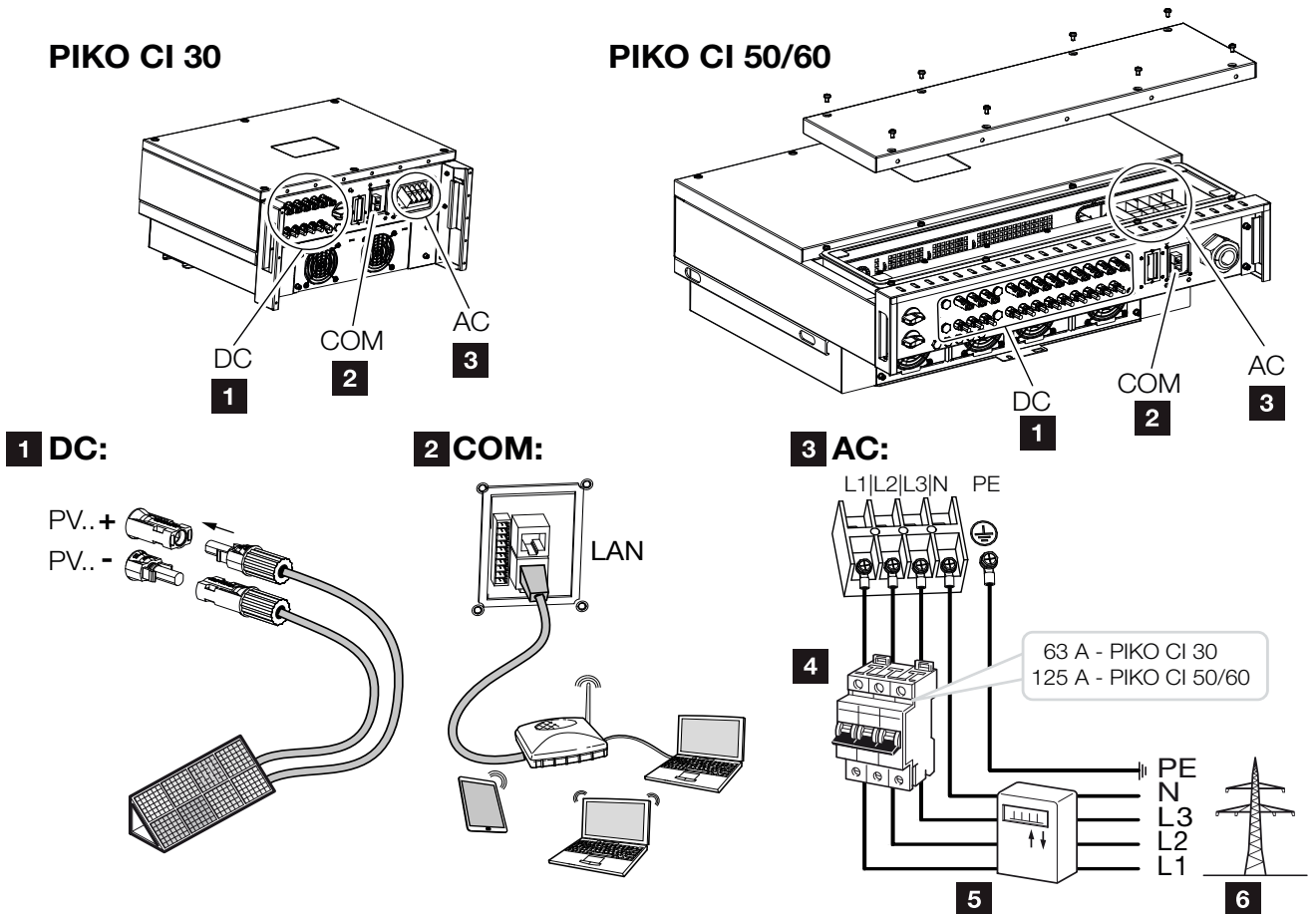

Fig. 15: Overview of electrical connections

Inverter connections

- 1 Connections for PV modules
- 2 Communication connections
- 3 AC connection **!**

External connections

- 4 Line circuit breaker
- 5 Energy meters (e.g. KOSTAL Smart Energy Meter)
- 6 Public grid



IMPORTANT INFORMATION

Make sure that the phases of the AC terminal and in the mains supply match.

This product may generate a direct current in the outer protective earthing conductor. If protective residual current devices (RCD) or residual current monitoring devices (RCM) are used, only type B RCDs or RCMs are permitted on the AC side.

Cable specification

■ AC grid connection

Select the conductor cross-section according to the rated output current and the type of routing. 

Take into account necessary reduction factors for ambient temperature and accumulation (when laying several cables without spacing).

Example: Ambient temperature 40 °C: Reduction factor 0.87 (according to DIN VDE 0100-520 / HD 60364-5-52).



INFO

For outdoor installation, use UV-resistant cable. Alternatively, lay the cable protected from solar radiation.

The 4-wire AC connection (3L/PE without N) is only possible in symmetrical networks.

Cable type	Cable length
Copper conductor 4-wire (3L/PE without N) or 5-wire (3L/N/PE)	max. 200m

PIKO CI	Wire cross-section	Cable diameter
30	10 - 25 mm ²	24 - 32 mm
50 / 60	30 - 50 mm ²	25 - 40 mm

■ Additional PE connection

PIKO CI	Wire cross-section
30	≥ 16 mm ²
50 / 60	≥ 35 mm ²

■ DC PV connections

Cable type	Wire cross-section	Cable diameter
Solar cable e.g. PV1-F	4 - 6 mm ²	6 - 8 mm

Connecting mains cable

1. ⚠️ Disconnect the power supply from the mains.
2. Secure AC connection against being switched on again.
3. Switch the DC switch on the inverter to OFF.
4. Correctly lay the mains cable from the power distributor to the inverter. ⚠️
5. Install the necessary safety devices - line circuit breakers, earth leakage circuit breakers - in the mains cable. ⚠️

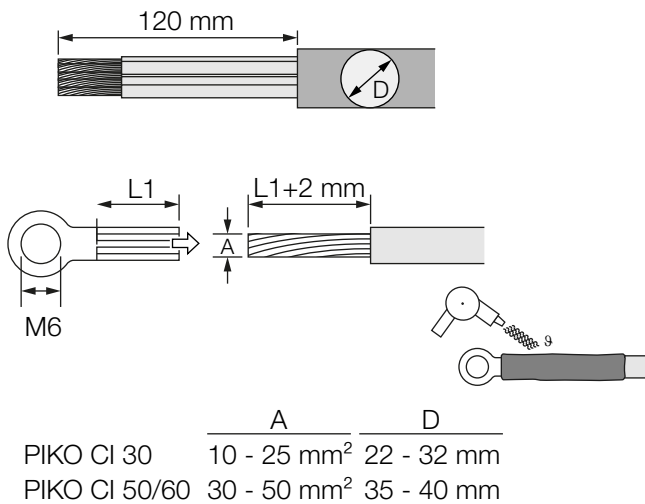

Fig. 16: Preparing AC cable

6. Strip 120 mm of insulation off the mains cable.
7. Fit suitable heat-shrinkable sleeves onto the wires. Strip insulation off ends of conductors and crimp the cable ring lug onto the ends of conductors.



DANGER

RISK OF DEATH DUE TO ELECTRICAL SHOCK AND DISCHARGE!

De-energise all devices and secure them against being switched on again.



IMPORTANT INFORMATION

Whenever working on the inverter, only ever use insulated tools to prevent short-circuits.



WARNING

RISK OF FIRE DUE TO OVERCURRENT AND HEATING OF THE MAINS CABLE!

Install line circuit breaker to secure against overcurrent.

8. PIKO CI 30:

Remove connection cover screws.
Lead mains cable through connection cover.

PIKO CI 50/60:

Remove screws on the bottom cover and take off the cover.
Lead the mains cable through the feed-through into the terminal compartment of the inverter.

Connect the mains cable to the AC terminal as instructed on the label. 

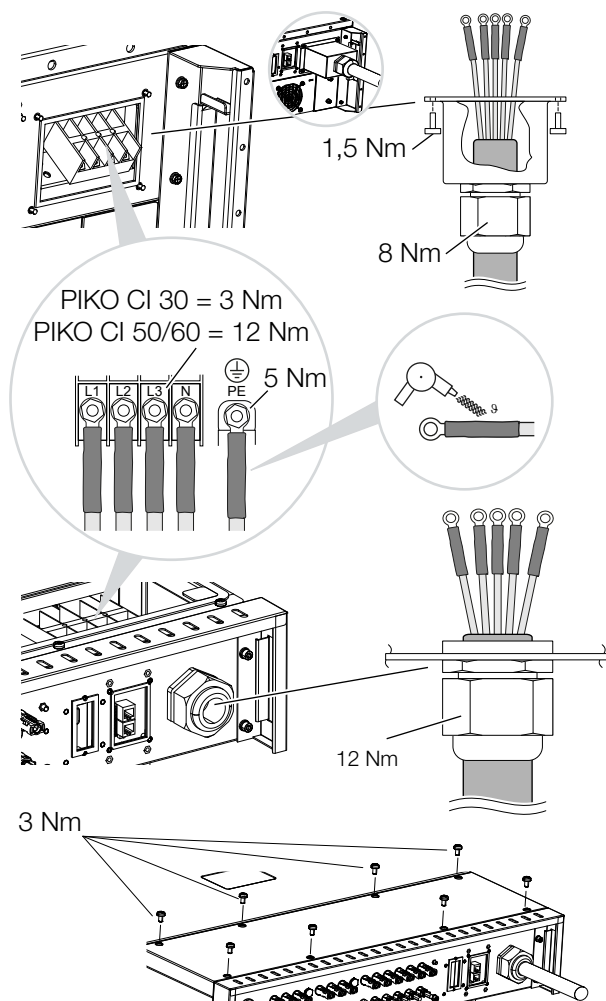

IMPORTANT INFORMATION

Make sure that the phases of the AC terminal and in the mains supply match.

The 4-wire AC connection (3L/PE without N) is only possible in symmetrical networks.

Fig. 17: Sealing AC connection

9. PIKO CI 30:

Attach connection to AC connection and screw it tight. Torque: 3 Nm.

PIKO CI 50/60:

Close the inverter and screw the cover tight. Torque: 3 Nm.

10. Seal the mains cable with sealing ring and union nut. Tighten the union nut.

11. In countries in which a second PE connection is prescribed, connect this at the marked place on the housing (outside).

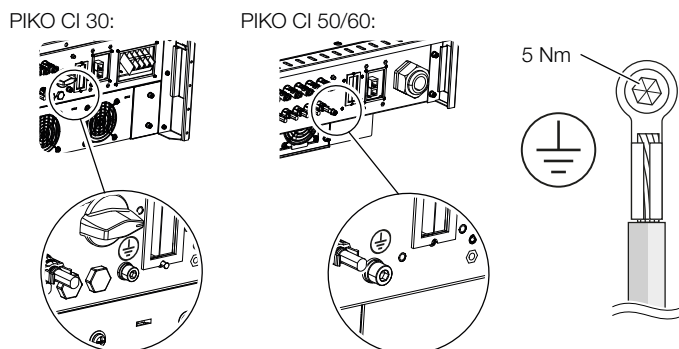

Fig. 18: Country-specific PE connection, outside

✓ Mains cable connected

3.5 Overview of communication connections

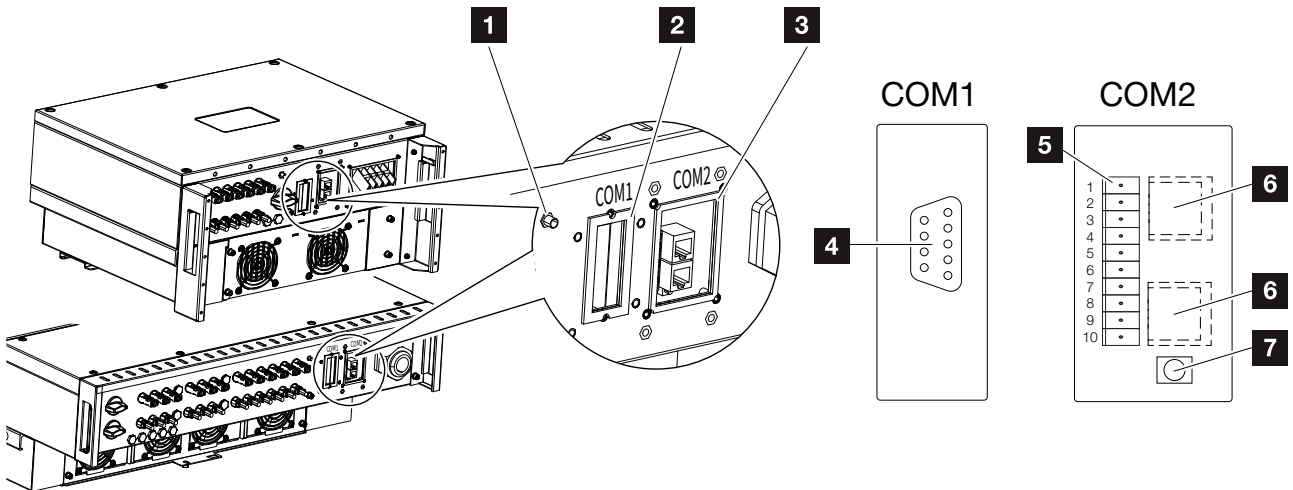

Fig. 19: Communication connections

- 1** WiFi antenna
- 2** COM1 connection panel
- 3** COM2 connection panel
- 4** Socket for communication module
- 5** Connector strip for communication interface with RS485 interface, digital inputs for ripple control receiver and grid and system protection connection
- 6** LAN connection
- 7** Reset button for commissioning address (WLAN)

Item	Designation	Pin	Explanation
5	Communication interface	1	GND (ground) for Remote and DI1...4
		2	Remote: Central system protection
		3	DI4: Input 4
		4	DI3: Input 3
		5	DI2: Input 2
		6	DI1: Input 1
		7	RS485/Modbus interface B (input, data -)
		8	RS485/Modbus interface A (input, data +)
		9	RS485/Modbus interface B (output, data -)
		10	RS485/Modbus interface A (output, data +)
6	RJ45 terminal	-	LAN connection 1
		-	LAN connection 2

3.6 Mounting WiFi antenna

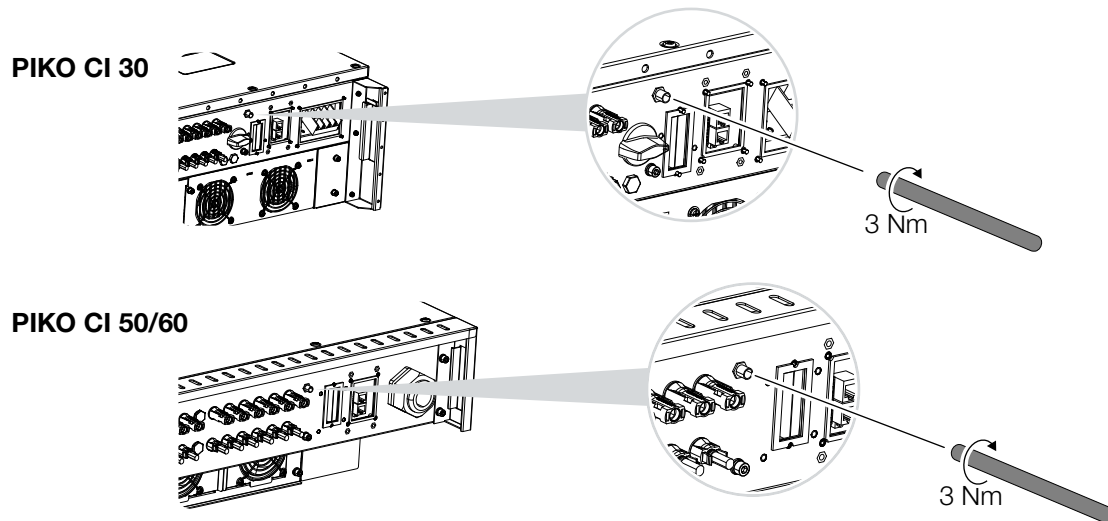

Fig. 20: Mounting WiFi antenna

1. Remove protective cap from connection thread on inverter.
 2. Screw the supplied WiFi antenna onto the stud bolt.
Tightening torque: 3 Nm
- ✓ WiFi antenna mounted

3.7 Types of communication

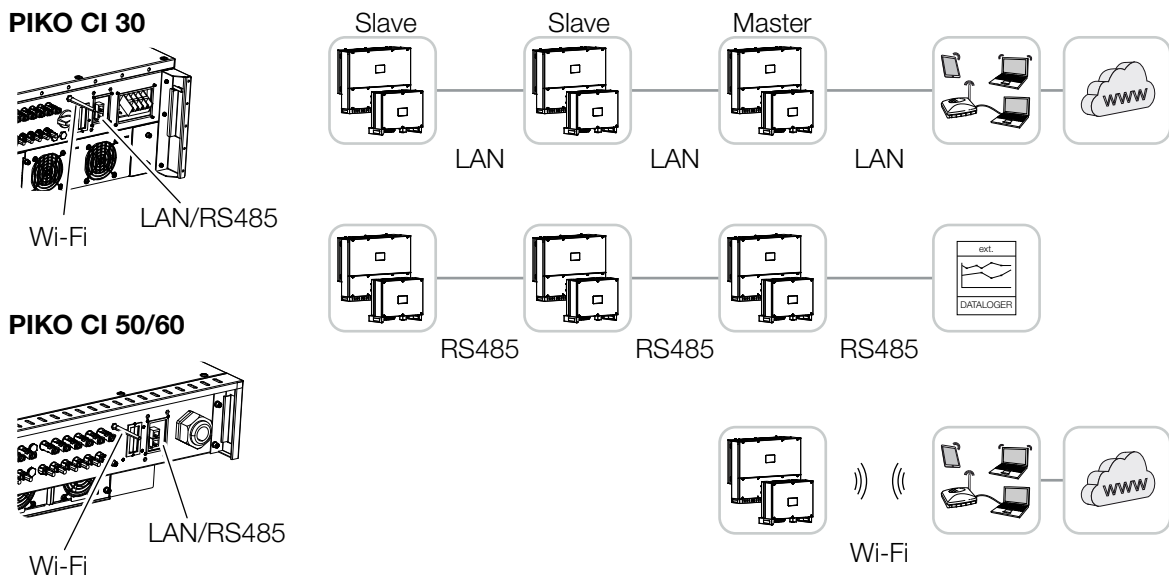

Fig. 21: Types of communication

The PIKO CI inverters have interfaces for LAN, RS485 Modbus and WiFi. There are therefore various possibilities for networking one or more inverters with each other and controlling them.

You can also combine different types of connections with each other. In a solar power plant, for example, it may be useful to network several inverters in the field in a wired manner (LAN/Ethernet or RS485), and to produce the connection to the local communication hub wirelessly via a radio link.

LAN / Ethernet

When networking via Ethernet, the inverter can be connected to the local network or the Internet. Use the RJ45 connection in the COM2 connection panel for this purpose. Computers, routers, switches and/or hubs or other devices can be connected to the network.

 **Ch. 3.8**

RS485 Modbus

Modbus is an industry standard for networking industrial measurement and control systems. A data logger or energy meter, for example, can be connected via this connection to control the connected inverters.

 **Ch. 3.9**

WLAN / WiFi

Via WiFi, one or more inverters can be integrated into the local WLAN network, e.g. via a router or hub.

 **Ch. 3.10**



INFO

Connecting the Ethernet cable to a router integrates the inverter into your own network and the inverter can then be contacted by all computers incorporated in the same network.



INFO

At a later date, there are also plans for a connection from inverter to inverter.

3.8 Communication via LAN

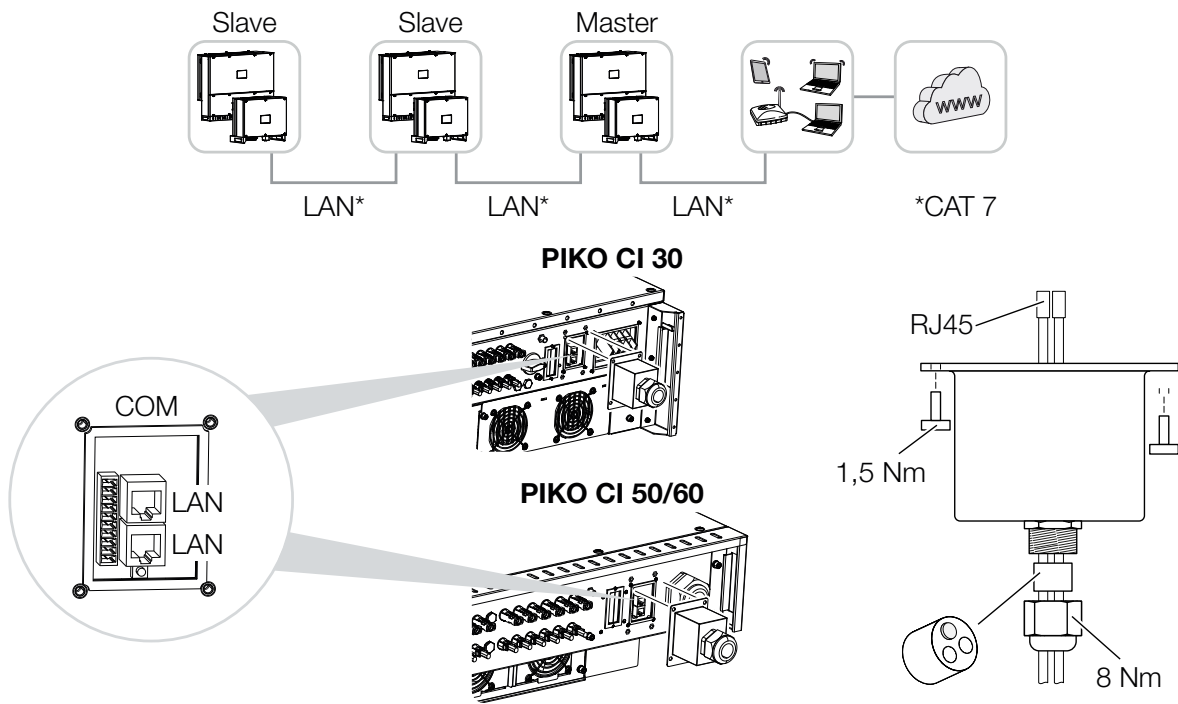

Fig. 22: Connecting inverter to LAN / Ethernet cable

1. De-energise the inverter.
2. Lead the Ethernet cable through the COM2 cover and seal it with sealing ring and union nut.
3. Tighten union nut to the prescribed torque.
Torque: 8 Nm (M25). **i**
4. Connect Ethernet cable to one of the LAN sockets in the COM2 connection panel. The second LAN socket is used to continue the network connection to further inverters.
5. Connect LAN/Ethernet cable to the computer or router. **i**



INFO

Use an Ethernet cable of category 7 (Cat 7, FTP) with a maximum length of 100 m as a network cable (Ethernet 10BaseT, 10/100 MBit/s).



INFO

After commissioning, the settings for the Ethernet connection can still be configured in the *KOSTAL PIKO CI* app. This includes, for example, the setting for IP mode, in which acquisition of an automatic IP address can be set.

6. The inverter is set as **master LAN** or slave using the **KOSTAL PIKO CI** app on each inverter. To do this, go to **Settings > Communication settings > Master/slave settings > Master/slave settings** and then select **Master LAN** or **Slave**. The master forwards data to the slave inverters. These may be, for example, feed-in limits.
- ✓ LAN cable connected

3.9 Communication via RS485

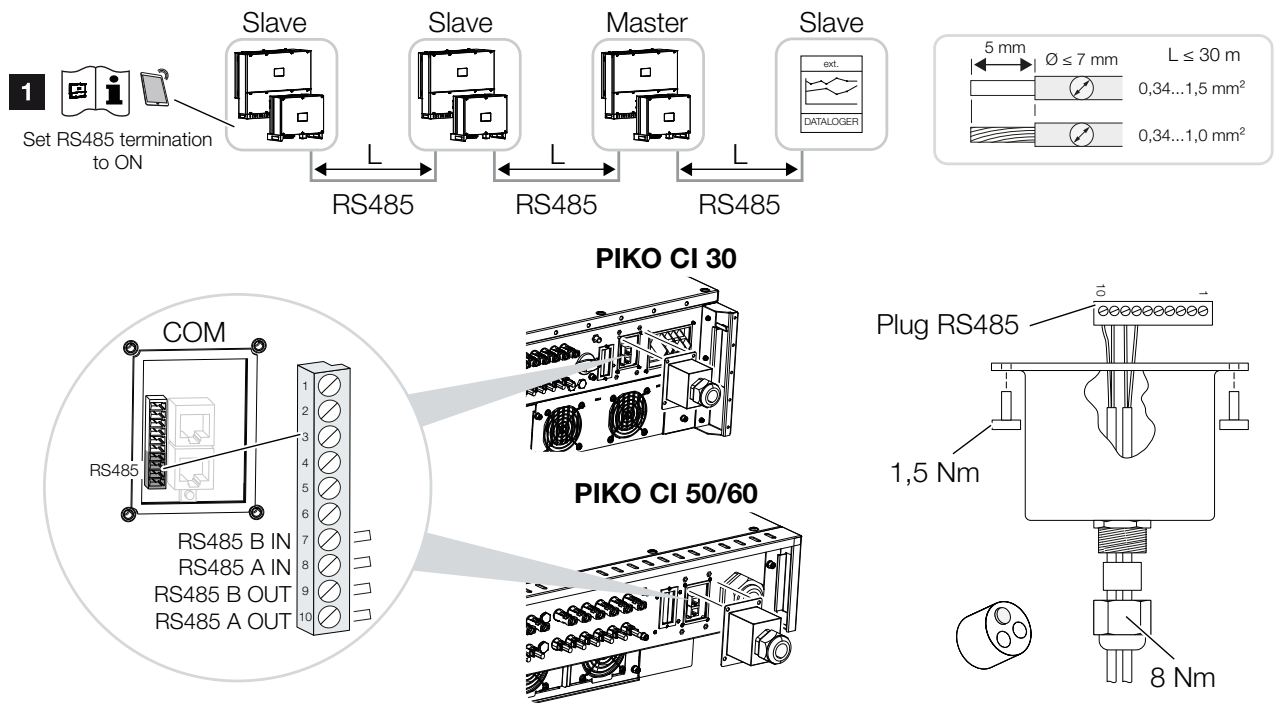





Fig. 23: Connecting inverter with RS485 cable

- 1** Activate RS485 termination on the last inverter

Connecting the RS485 connection

1. De-energise the inverter.
 Ch. 4.2
 2. Lead the RS485 cable through the COM2 cover and seal it with sealing ring and union nut.
 3. Tighten union nut to the prescribed torque.
Torque: 8 Nm (M25). 
 4. Fit RS485 cable to the supplied plug (RS485 x in) and plug it into the interface in the COM2 connection panel. RS485 out is used to continue the network connection to further inverters.
 5. Connect RS485 cable to external device (e.g. data logger). 
 6. The inverter is set as **master RS485** or slave using the **KOSTAL PIKO CI** app on each inverter. To do this, go to **Settings > Communication settings > Master/slave settings > Master/slave settings** and then select **Master RS485** or **Slave**. The master forwards data to the slave inverters. These may be, for example, feed-in limits.
 7. The RS485 termination of the last inverter must be set to ON in the **KOSTAL PIKO CI** app. This can be done under **Settings > Communication Settings > RS485 Settings > Terminating Resistor**.
- ✓ RS485 cable connected



INFO

Use an Ethernet cable of category 7 (Cat 7, FTP) with a maximum length of 100 m as a network cable (Ethernet 10BaseT, 10/100 MBit/s).



INFO

After commissioning, the settings for the RS485 connection still have to be configured in the **KOSTAL PIKO CI** app.
This includes, for example, setting the transmission speed.

3.10 Communication via WiFi

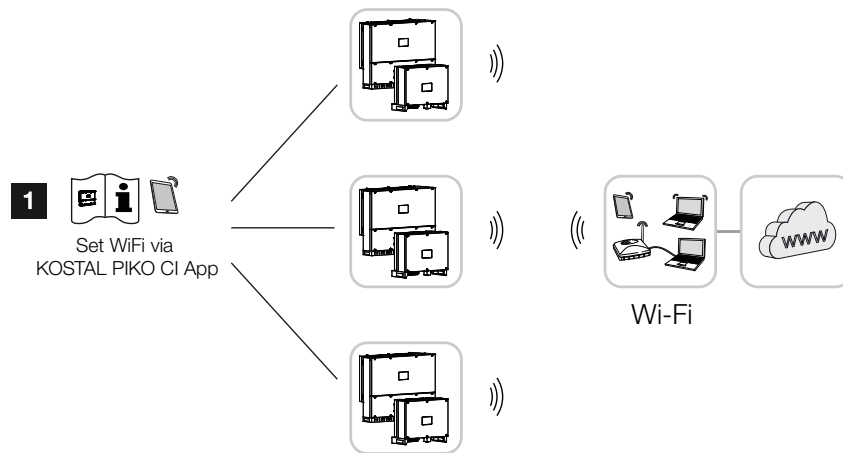



Fig. 24: Connecting inverters via WiFi

1 WiFi settings

1. After commissioning, the WiFi settings in the **KOSTAL PIKO CI** app must be configured in each inverter. 
2. To do this, go to the following menu item and configure the settings:
Settings > Communication settings > WLAN settings > Select WLAN connection

✓ Inverter connected via WiFi



INFO



If you have forgotten the WLAN password, you can reset it to the default value **12345678** using the reset button under the cover for COM2.

3.11 Connecting the KOSTAL Smart Energy Meter

Connecting a KOSTAL Smart Energy Meter allows generation values and consumption values to be recorded or the output power of the inverter into the public grid to be controlled.

The energy meter is installed in the meter cabinet or in the main distribution board. Please also refer to the operating documentation of the KOSTAL Smart Energy Meter. 

The KOSTAL Smart Energy Meter can be connected to the PIKO CI in two different ways. The connection method must then be set via the KOSTAL PIKO CI app.

-  “Communication connection for KOSTAL Smart Energy Meter via LAN”
-  “Communication connection for KOSTAL Smart Energy Meter via RS485”



IMPORTANT INFORMATION

Only energy meters that have been approved for this inverter may be used.

You will find an up-to-date list of the approved energy meters on our homepage in the download area for the product.

The following energy meters are currently approved:

- KOSTAL Smart Energy Meter

Communication connection for KOSTAL Smart Energy Meter via LAN

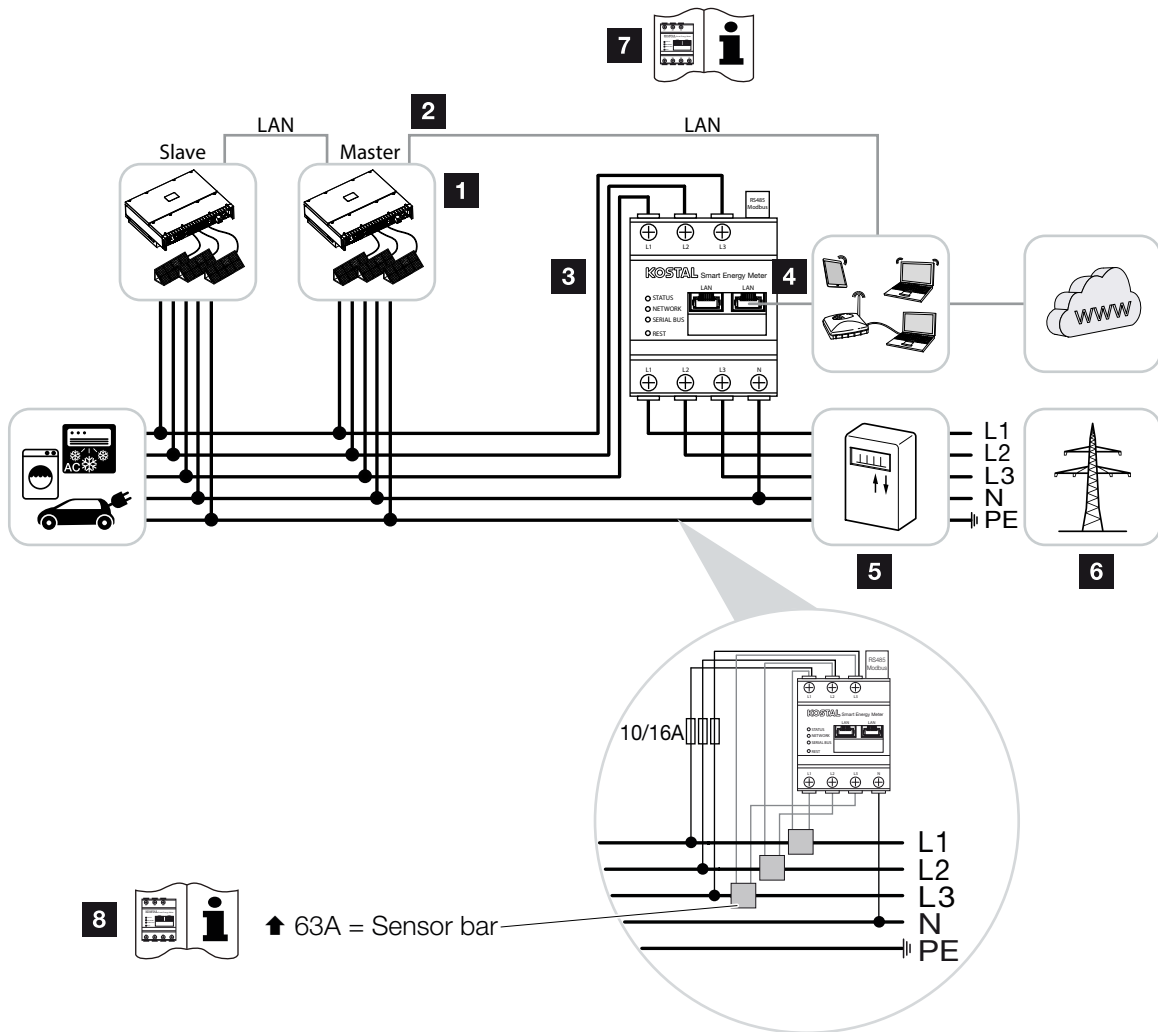

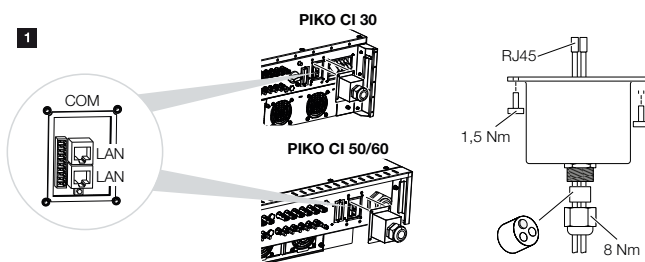

Fig. 25: Wiring diagram for energy meter LAN - grid connection

- 1 Inverter
- 2 LAN interface for inverter
- 3 KOSTAL Smart Energy Meter
- 4 LAN interface for KOSTAL Smart Energy Meter
- 5 Feed meter
- 6 Public grid
- 7 Read the operating manual for the KOSTAL Smart Energy Meter.
- 8 Use a current transformer for currents above 63 A. Read the operating manual for the KOSTAL Smart Energy Meter

Connecting the KOSTAL Smart Energy Meter

1. De-energise the mains cable. 
2. Install the KOSTAL Smart Energy Meter as shown at the grid connection point in the house grid.
3. Feed the Ethernet cable on the inverter through the COM2 cover and seal it with sealing ring and union nut. Tighten union nut to the prescribed torque. Torque: 8 Nm (M25). 



4. Connect Ethernet cable to one of the LAN sockets in the COM2 connection panel. The second LAN socket is used to continue the network connection to further inverters.
5. Mount COM2 cover cap. Torque: 1.5 Nm
6. Connect the other end of the Ethernet cable to the router.



DANGER

RISK OF DEATH DUE TO ELECTRICAL SHOCK AND DISCHARGE!

De-energise all devices and secure them against being switched on again.



INFO

LAN cable requirements:

- CAT7
- Length max. 100

7. Establish a LAN connection from the KOSTAL Smart Energy Meter to the router.
8. In this variant, the KOSTAL Smart Energy Meter runs as a slave and transmits data to the inverter.
9. Set the **KOSTAL Smart Energy Meter** to **ON** under **Modbus settings > Modbus TCP > Slave (Activate TCP slave)**.
10. To make the home consumption visible in the **KOSTAL Solar Portal**, set it to **ON** in the **KOSTAL Smart Energy Meter** under **Inverter > Solar Portal > Activate Solar Portal**.
11. After commissioning, the following settings still have to be configured in the **KOSTAL PIKO CI app**.
12. The use and installation position of the KOSTAL Smart Energy Meter (KSEM) must be set in the **KOSTAL PIKO CI** app on the master inverter. This can be set under **Settings > Inverter settings > Power adjustment/control > Energy management > Power limitation function > KSEM** and **Settings > Inverter settings > Power adjustment/control > Energy management > Energy meter position > Grid connection point**.
13. The Modbus IP address used in the KOSTAL Smart Energy Meter can be set under **Settings > Power adjustment/control > Energy management > IP address of the energy meter**.

14. The **KOSTAL Smart Energy Meter** is connected to the master inverter. If not already done, configure this inverter as a **master LAN**.

This can be selected under **Settings > Communication Settings > Master/Slave Settings > Master LAN**.

15. All other inverters connected to the master inverter must be configured as **slaves**.

This can be selected under **Settings > Communication Settings > Master/Slave Settings > Slave**.

16. For all slave inverters, the use and installation position of the KOSTAL Smart Energy Meter must be set in the **KOSTAL PIKO CI** app as an **external device** and at the **grid connection point**.

This can be selected under **Settings > Inverter settings > Power adjustment/control > Energy management > Power limitation function** and **Power limitation mode**.

- ✓ Inverter connected to the KOSTAL Smart Energy Meter.

Communication connection for KOSTAL Smart Energy Meter via RS485

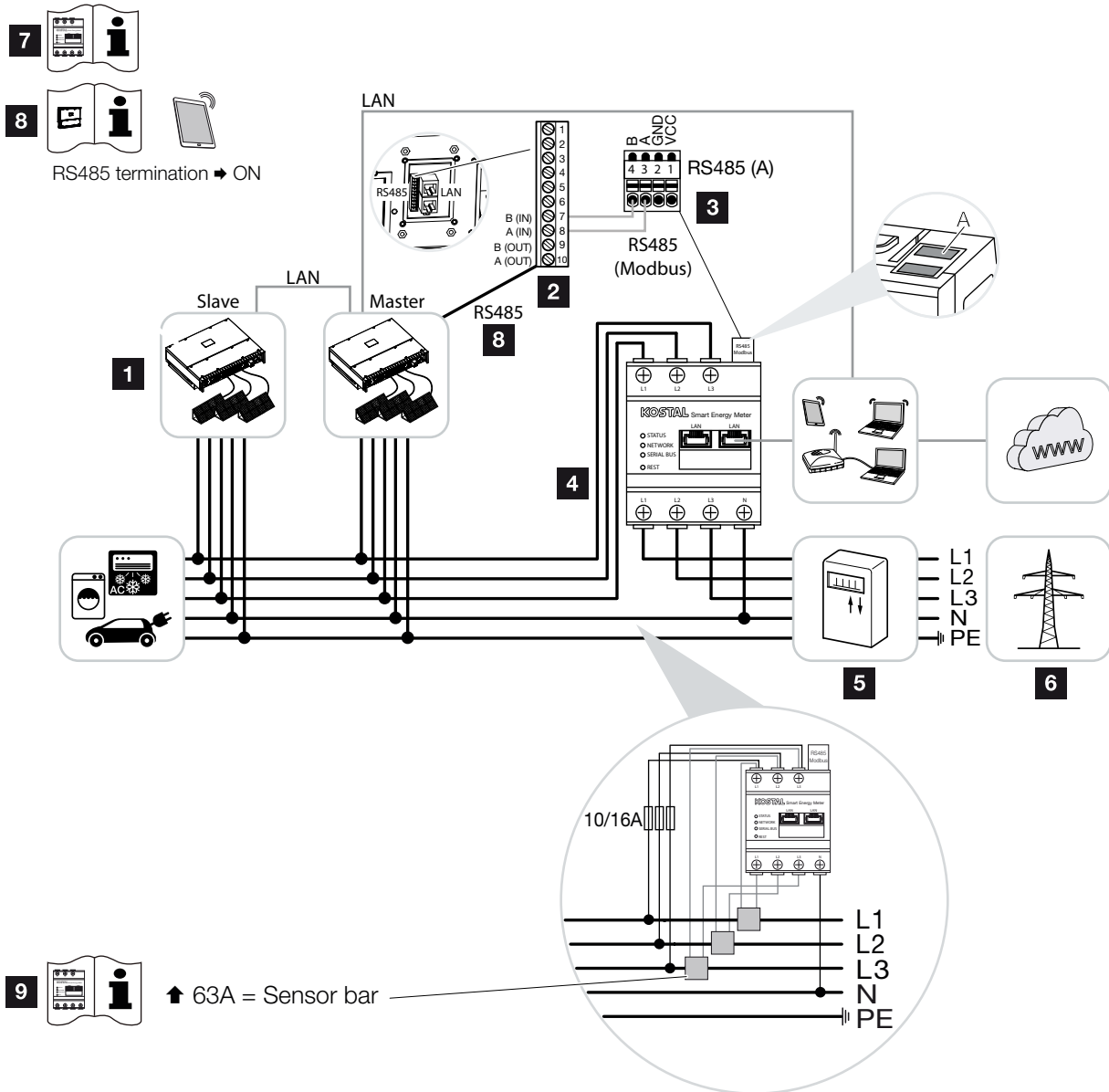
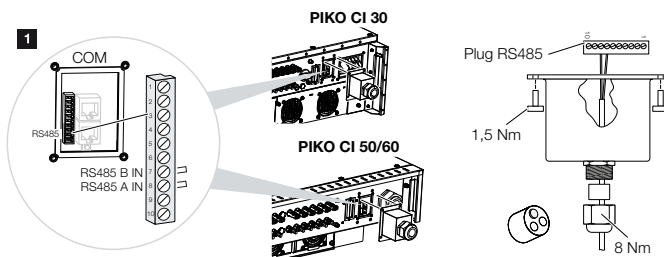

Fig. 26: Wiring diagram for energy meter RS485 - grid connection

- 1 Inverter
- 2 RS485 interface for inverter
- 3 RS485 interface for KOSTAL Smart Energy Meter
- 4 KOSTAL Smart Energy Meter
- 5 Feed meter
- 6 Public grid
- 7 Read the operating instructions for the KOSTAL Smart Energy Meter
- 8 Set RS485 termination in **KOSTAL PIKO CI** app to ON
- 9 Use a current transformer for currents above 63 A. Read the operating manual for the KOSTAL Smart Energy Meter

Connecting the KOSTAL Smart Energy Meter

1. De-energise the mains cable. ⚠
2. Install the KOSTAL Smart Energy Meter as shown at the grid connection point in the house grid.
3. Correctly route the communication cable from the inverter to the control cabinet and connect it to the KOSTAL Smart Energy Meter according to the wiring diagram provided by the manufacturer. ⓘ
4. Feed the communication cable through the cover of the inverter for COM2 connection panel. Seal connection with sealing ring and union nut.



DANGER

RISK OF DEATH DUE TO ELECTRICAL SHOCK AND DISCHARGE!

De-energise all devices and secure them against being switched on again.



INFO

Requirements of communication cable:

- Wire cross section:
0.34 - 1.5 mm² (rigid)
0.34 - 1.0 mm² (flexible)
- Length max. 30
- Length of stripped insulation approx. 5 mm

5. Connect the communication cable to the plug connector for the communication interface. Please note the pin assignment.
Torque: 0.2 Nm.
6. Connect the plug connector on the inverter to communication interface in COM2 connection panel.
7. Establish LAN connection from KOSTAL Smart Energy Meter and inverter to the Internet.
8. In this variant, the KOSTAL Smart Energy Meter runs as a slave and transmits data to the inverter.
9. In the KOSTAL Smart Energy Meter, select the PIKO CI for the RS485 A interface. Refer to the operating instructions for the KOSTAL Smart Energy Meter.
10. Mount COM 2 cover cap.
Torque: 1.5 Nm
11. After commissioning, the RS485 termination in the **KOSTAL PIKO CI** app must be set to **ON** on the last inverter connected to the RS485 communication cable.
This can be done under **Settings > Communication Settings > RS485 Settings > Terminating Resistor**.

12. The use and installation position of the KOSTAL Smart Energy Meter (KSEM) must be set in the **KOSTAL PIKO CI** app on the master inverter.
This can be set under **Settings > Inverter settings > Power adjustment/control > Energy management > Power limitation function > KSEM** and **Settings > Inverter settings > Power adjustment/control > Energy management > Energy meter position > Grid connection point**.
 13. The inverter to which the KOSTAL Smart Energy Meter has been connected must be configured as the master.
This can be selected under **Settings > Communication Settings > Master/Slave Settings > Master RS485**.
 14. All other inverters connected to the master inverter must be configured as **slaves**.
This can be selected under **Settings > Communication Settings > Master/Slave Settings > Slave** (default setting).
 15. For all slave inverters, the use of an energy meter must be deactivated under **Settings > Inverter settings > Power adjustment/control > Energy management > Power limitation function > Deactivated** (default setting).
- ✓ Inverter connected to the KOSTAL Smart Energy Meter.

3.12 Connecting central grid and system protection

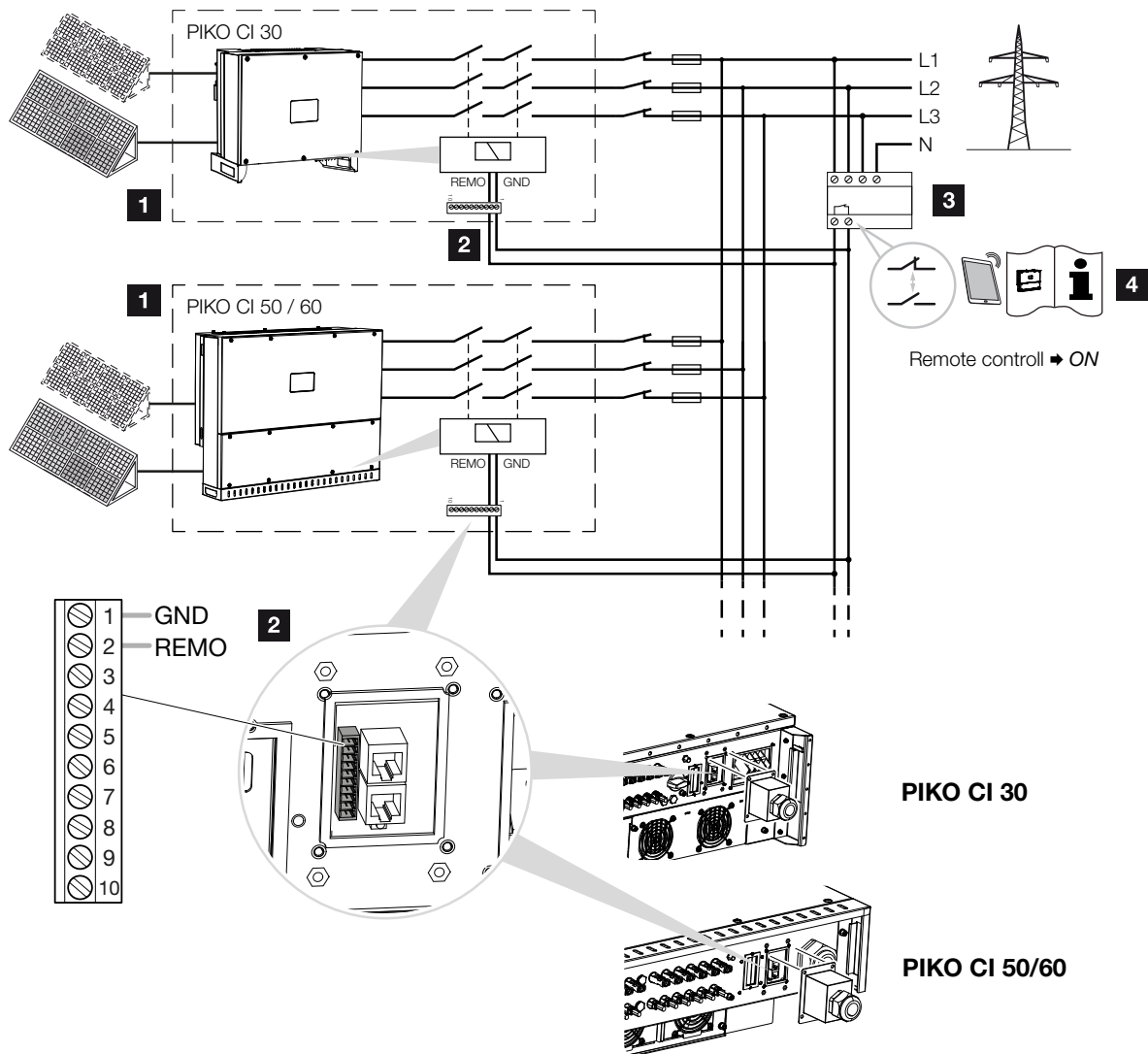



Fig. 27: Central grid and system protection with circuit breaker

- 1 PIKO CI inverter
- 2 Connection
- 3 Grid and system protection
- 4 Activation of grid and system protection via **KOSTAL PIKO CI** app

Central grid and system protection is required in some countries. This monitors the voltage and frequency in the grid and in the event of a fault, shuts down the photovoltaic systems by means of a circuit breaker.

If your energy supplier requires central grid and system protection for your system, install an external monitoring device, which switches off the inverter via a normally open or normally closed contact. An additional circuit breaker is not necessary, as this is not required by the inverter's internal switches.

1. De-energise the mains cable. 
2. Mount the monitoring device in the control cabinet or power distributor.
3. Correctly route the communication cable from the inverter to the control cabinet and connect according to the wiring diagram provided by manufacturer. 
4. Pass the communication cable through the cover for the COM2 connection panel. Seal connection with sealing ring and union nut.
5. Connect the communication cable to the plug connector for the communication interface. Please note the pin assignment.
Torque: 0.2 Nm.



DANGER

RISK OF DEATH DUE TO ELECTRICAL SHOCK AND DISCHARGE!

De-energise all devices and secure them against being switched on again.



INFO

Requirements of communication cable:

- Wire cross section:
0.34 - 1.5 mm² (rigid)
0.34 - 1.0 mm² (flexible)
- Length max. 30
- Length of stripped insulation approx. 5 mm

6. Connect plug connector on inverter to communication interface in COM2 connection panel.

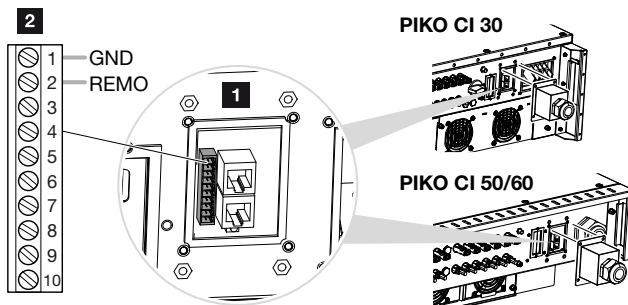

Fig. 28: Central system protection - connection

- 1 COM2 connection panel
 - 2 Communication interface
 - 3 Plug connectors
7. After commissioning, the function must be activated in each inverter via the **KOSTAL PIKO CI** app. This can be activated under **Settings > Basic Settings > External Shutdown > ON**.
- ✓ Inverter set up for grid and system protection function.

3.13 Connecting the ripple control receiver

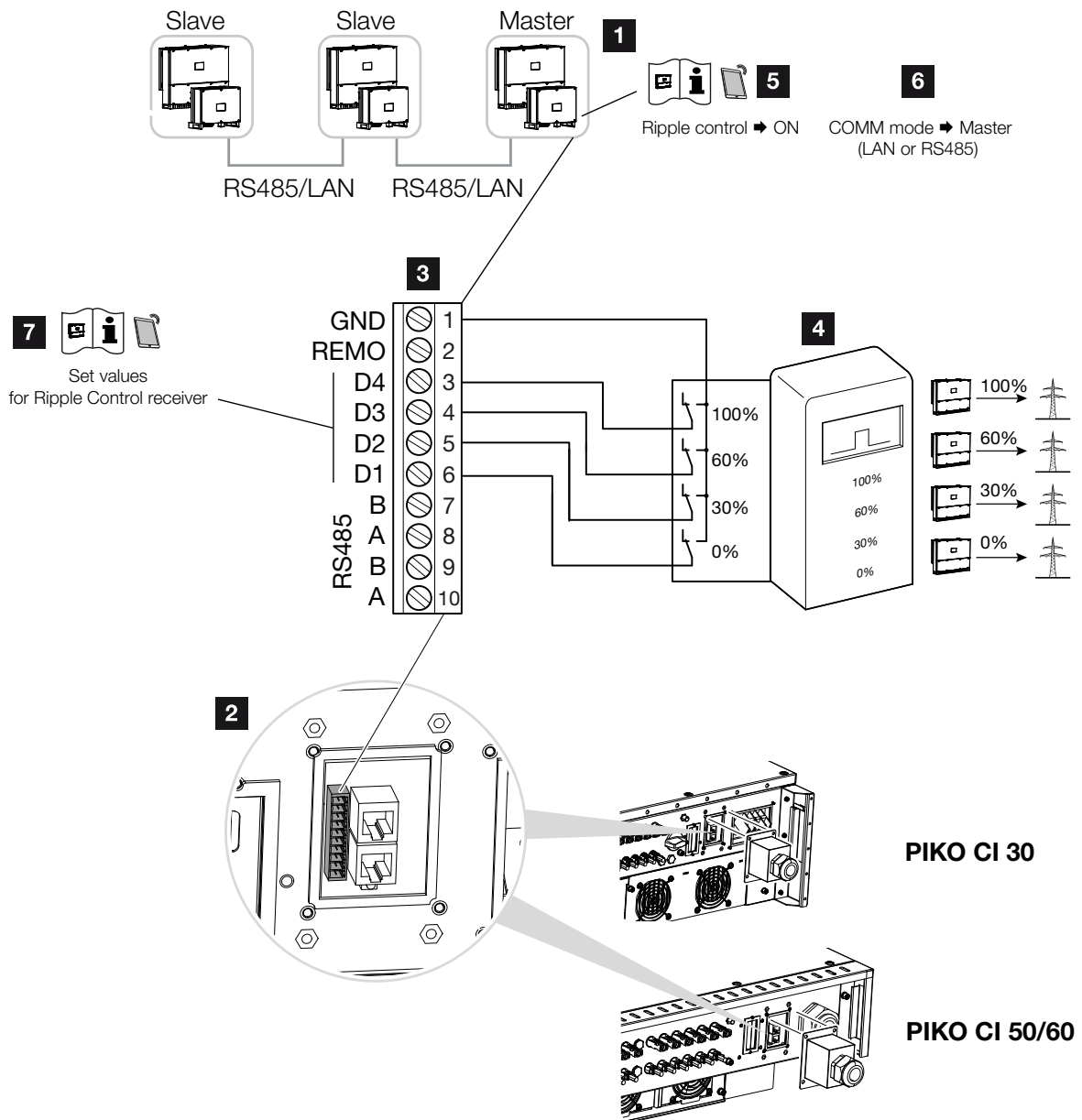



Fig. 29: Connection of the ripple control receiver

- 1 Inverter to which the ripple control receiver is connected
- 2 COM2 connection panel
- 3 Plug for communication interface
- 4 Ripple control receiver
- 5 Activate the ripple control receiver in the **KOSTAL PIKO CI** app
- 6 Activate communication mode (LAN or RS485) in the **KOSTAL PIKO CI** app
- 7 Activate switching values for ripple control receivers in the **KOSTAL PIKO CI** app

Several energy supply companies offer the owners of PV systems the possibility of regulating their system with variable active power control and thus increasing the feed-in into the public grid to up to 100 %. 



Ask your energy supply company or installer what application rule applies to you or whether there is an alternative (e.g. smart meter) better suited to you.

If a ripple control receiver is already connected to another KOSTAL inverter in your home network, you can use the control signals of this ripple control receiver.



INFO

In some applications, the digital energy meter KOSTAL Smart Energy Meter can be regarded as a cost-effective alternative to the ripple control receiver. Here the feed-in may well be limited by the energy supply company, but the inverter controls the flow of energy (self-consumption in house grid and feed-in to the public grid) in such a way that the self-produced energy is not lost or loss is kept to an absolute minimum.

1. De-energise the mains cable. 
 2. Fit ripple control receiver in control cabinet or power distributor.
 3. Correctly route the communication cable from the inverter to the control cabinet and connect following wiring diagram provided by manufacturer. 
 4. Pass the communication cable through the cover for the COM2 connection panel. Seal connection with sealing ring and union nut.
 5. Connect the communication cable to the plug connector for the communication interface. Please note the pin assignment.
Torque: 0.2 Nm.
 6. Connect plug connector on inverter to communication interface in COM2 connection panel.
 7. Open the **KOSTAL PIKO CI** app and connect to the inverter to which the ripple control receiver is connected.
 8. Activate the ripple control receiver in the **KOSTAL PIKO CI** app under **Settings > Inverter settings > Power adjustment/control > Ripple control receiver (RSE) > Activate ripple control receiver > ON**.
 9. Set switching values for the ripple control receiver under **Settings > Inverter settings > Power adjustment/control > Ripple control receiver (RSE) > RSE active power / RSE reactive power / RSE power factor**.
 10. Set the communication (LAN or RS485) on the master inverter to the other inverters under **Settings > Communication settings > Master/slave settings > Master/slave settings > Master**.
- ✓ The ripple control receiver is connected



DANGER

RISK OF DEATH DUE TO ELECTRICAL SHOCK AND DISCHARGE!

De-energise all devices and secure them against being switched on again.



INFO

Requirements of communication cable:

- Wire cross section:
0.34 - 1.5 mm² (rigid)
0.34 - 1.0 mm² (flexible)
- Length max. 30
- Length of stripped insulation approx. 5 mm

3.14 Closing the inverter

1. Tighten all cable glands and check that they are properly sealed.
2. Check the fit of connected wires and braids.
3. Remove any foreign objects (tools, wire cuttings, etc.) from the inverter.
4. Mount the cover and screw it tight.
5. Mount the cover on the PIKO CI 50 / 60 and screw it tight (1.5 Nm).

3.15 Connecting PV modules

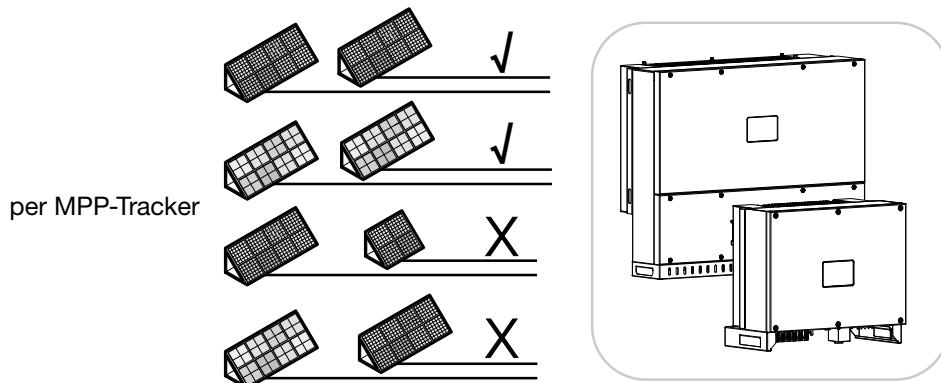



Fig. 30: Possible PV modules

Connectable solar modules

When selecting the PV modules to be connected to PIKO CI series inverters, note the following:

- Only connect PV modules according to IEC 61730 Class A.
- Do not ground the PV cables.
- Use suitable cables with the largest possible cross-section for connecting the PV modules! 
- Per MPP tracker:
 - Only connect PV modules of the same type to a MPP tracker, i.e.
 - same manufacturer,
 - same type,
 - same power,
 - same size.

Different module types, sizes and connected loads and also a different number of PV modules can be connected to different MPP trackers.



IMPORTANT INFORMATION

Use flexible and tin-plated cables with double insulation according to EN50618.

We recommend a cross-section of 6 mm².

Please observe the specifications of the plug manufacturer and the technical data for the inverter.

Solar module connections

Please note the following points before connecting the PV modules: ⚠ ⚠ ⚠

- Check the planning and the wiring of the modules for plausibility.
- Measure and record the DC idling voltage and polarity of the PV modules. The idling voltage of the PV modules must be in the voltage range between U_{MPPmin} and U_{MPPmax} .

PIKO CI	$U_{DC,max}$	$I_{MPP,max}$	$I_{String,max}$
30	≤ 1000 V	≤ 37.5 A	≤ 14 A
50/60	≤ 1000 V	≤ 33.0 A	≤ 14 A

- Make sure that the maximum short-circuit current of the PV modules is less than the permitted value.
- Make sure that the PV modules are not short-circuited.
- Make sure that the inverter is closed when the PV modules are connected.
- Make sure that when connecting several inverters there is no cross-connection of the PV modules.

Failure to observe these requirements will render any warranty, guarantee or other liability offered by the manufacturer null and void.

Preparing PV connector

The PIKO CI inverters use Helios H4 connectors from Amphenol.

- During installation, it is essential that the current specifications of the manufacturer are observed. ¹
- Only use installation tools from the manufacturer.
- When mounting the sockets and plugs, ensure that the solar modules have the correct polarity.



DANGER

RISK OF DEATH DUE TO ELECTRICAL SHOCK AND DISCHARGE!

The PV generators/cables may be live as soon as they are exposed to light.



WARNING

SERIOUS BURNS DUE TO ARCS ON THE DC SIDE!

During operation, dangerous arcs can occur when pulling or plugging the DC connections. Before connecting the DC connectors, de-energise the DC side. DC switches must be in the OFF position.



WARNING

FIRE HAZARD DUE TO IMPROPER INSTALLATION!

Incorrectly fitted plugs and sockets may heat up and cause a fire. During installation, be sure to follow the manufacturer's requirements and manual. Properly mount plugs and sockets.

¹ Information about the Amphenol installation specification is available from:

Installing PV connectors

- Strip approx. 9 mm of insulation off the solar cable.

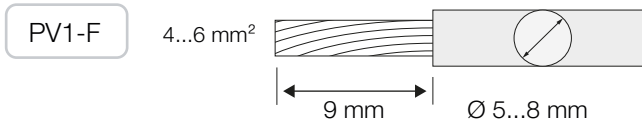

- Insert stripped wire end into crimped neck of contact.

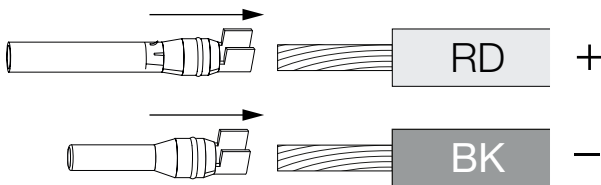

- Crimp the contact with a suitable crimping tool.

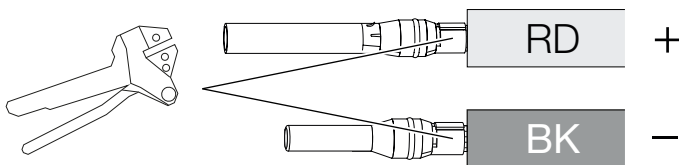

- Insert contact into plug connector until the contact clicks into place tangibly and audibly. 

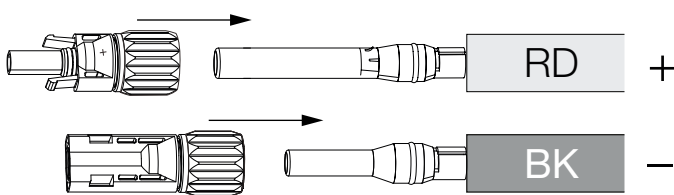

- Tighten nut on connector (3 Nm).

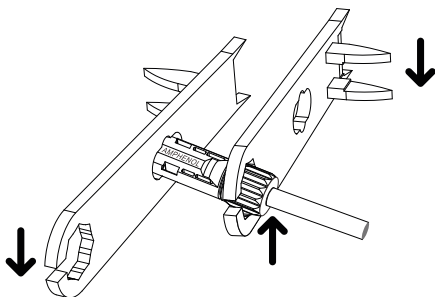

- ✓ PV connector installed



DANGER

RISK OF DEATH DUE TO ELECTRICAL SHOCK AND DISCHARGE!

Disconnect the DC cables by interrupting the connections to the PV modules.

If it is not possible to disconnect the DC cables, observe the rules for working under voltage.

Use personal protective equipment, hard hat, visor or goggles, protective suit, insulating gloves.

Use an insulating protective mat as an underlay.

Only use insulated tools.



INFO

Once snapped into the housing, the contact cannot be removed from the plug connector.

Selecting PV inputs

If the inverter's DC inputs are not fully occupied, distribute the input assignment according to the following tables: 

PIKO CI	$U_{DC,max}$	$I_{MPP,max}$	$I_{String,max}$
30	$\leq 1000\text{ V}$	$\leq 37.5\text{ A}$	$\leq 14\text{ A}$
50/60	$\leq 1000\text{ V}$	$\leq 33.0\text{ A}$	$\leq 14\text{ A}$

PIKO CI	Connected PV strings	MPP tracker	
		1	2
		Used DC input	
30	1	1...6	
	2	1	4
	3	1, 2	4
	4	1, 2	4, 5
	5	1, 2, 3*	4, 5
	6	1, 2, 3*	4, 5, 6*

* only with $I_{Strings,max} \leq 12,5\text{ A}$ per DC input

PIKO CI	Connected PV strings	MPP tracker			
		1	2	3	4
		Used DC input			
50/60	1	2...10/12			
	2	2	6		
	3	2	6	10	
	4	2	6	10	13
	5	2, 3	6	10	13
	6	2, 3	6, 7	10	13
	7	2, 3	6, 7	10, 11	13
	8	2, 3	6, 7	10, 11	13, 14
	9	2, 3, 4*	6, 7	10, 11	13, 14
	10	2, 3, 4*	6, 7, 8*	10, 11	13, 14
60	11	2, 3, 4*	6, 7, 8*	9, 10, 11*	13, 14
	12	2, 3, 4*	6, 7, 8*	9, 10, 11*	12, 13, 14*

* only with $I_{Strings,max} \leq 11\text{ A}$ per DC input



INFO

Only connect PV modules of the same type to a MPP tracker, i.e.

- same manufacturer,
- same type,
- same power,
- same size.

Connecting PV modules to the inverter

The DC cables of the solar modules must not be connected to the inverter under load ⚠.

1. Unlock the AC connection of the inverter by switching off the circuit breaker.
2. Turn the DC switch on the inverter to "OFF".
3. Check polarity of DC cables before connecting them ⓘ.

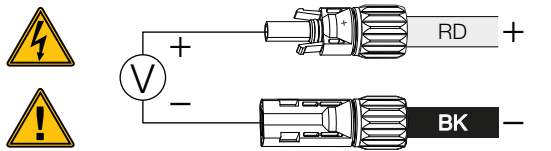

	$U_{DC,max}$	$I_{MPP,max}$	$I_{string,max}$
PIKO CI 30	$\leq 1000\text{ V}$	$\leq 37,5\text{ A}$	$\leq 14\text{ A}$
PIKO CI 50/60	$\leq 1100\text{ V}$	$\leq 33,0\text{ A}$	$\leq 14\text{ A}$

4. Remove protective caps from input terminals ⓘ.
5. Fit plug connectors of the individual PV strings into the DC inputs PV+ and PV- in pairs until they engage tangibly and audibly.

PIKO CI 30

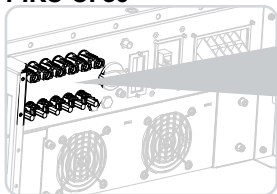

PIKO CI 50/60

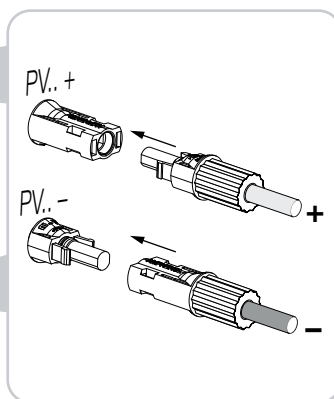
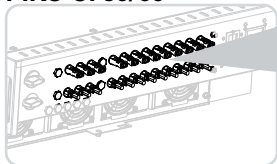

- ✓ The PV modules are connected.



DANGER

RISK OF DEATH DUE TO ELECTRICAL SHOCK AND DISCHARGE!

Switch off the inverter on both the AC and DC sides.



INFO

Observe national regulations! In France, in particular, the inverter and the supply lines must be labelled, for example.

The installer is responsible for obtaining and affixing the prescribed markings.



INFO

Keep the protective caps of the PV connections for future use.



3.16 Initial commissioning

Commissioning and setting the necessary operating parameters is undertaken wirelessly using the **KOSTAL PIKO CI** app and a tablet or your smartphone.

Installing KOSTAL PIKO CI app

1. Download the **KOSTAL PIKO CI** app from the Apple App Store or Google Play Store onto your tablet or smartphone.

Connecting inverter to app

1. Turn on the WiFi/WLAN function on your tablet or smartphone.
2. Call up the WiFi/WLAN settings.
3. Switch on the inverter.
4. Make a note of the type and serial number of the inverter you want to start up. This information can be found on the type plate.
5. On your tablet or smartphone, find and select the WLAN network of your inverter. 
The inverter's SSID is composed of the type and serial number of the inverter.
Example: PIKO_CI_50_12345678
6. Enter as password: **12345678** and confirm your entry. 
7. Answer the **Check** question with **Stay**.
8. Launch the app. The app displays the inverters found.
9. Select the inverter you want to start up.
- ✓ When the app displays the message **Connect**, the inverter is connected.



INFO

If there are a lot of metal parts in the installation environment of the inverter - e.g. support frames, connecting cables, enclosures - the range of the radio connection may be impaired. Change position if you experience connection problems.





INFO

The default password is: **12345678**. This should be changed after the initial commissioning.

If you have forgotten the WLAN password, you can reset it to the default value using the reset button under the cover for COM2.

Procedure for initial commissioning

1. In the app, select the **Settings** page.
 - ➔ On the **Settings** page, the app shows you various menus where you can configure settings.
 2. In order to have access to all relevant settings, go to **User management** and then touch the **Change user** button.
 3. Enter the password **superadmin** .
 4. Configure the settings for inverter operation and on the **Settings** page, select **Inverter settings**. .
 5. Select language and confirm.
To do so, use the arrow keys to select a language. Confirm using **ENTER**.
- ✓ The inverter is in operation and can now be used. Initial commissioning is completed.

The following settings still need to be configured after initial commissioning:

- Inverter settings made by the installer
- Prescribed settings for grid feed-in by the energy supply company
- Change the password or update the inverter software.



INFO

The installation process may vary depending upon the software version of the inverter.

Information about the menus

 **Ch. 5.5**



INFO

The default password for the administrator is **admin**. This can be used to configure a multitude of settings.

This password should be changed after the initial commissioning.

To configure network settings and other important settings (e.g. power limitations or network policies) you must enter the password **superadmin** when logging in as administrator. This password cannot be changed.



INFO

Observe national regulations! In France, in particular, the inverter must be labelled, for example, to indicate the settings.

The installer is responsible for obtaining and affixing the prescribed markings.

4. Operation and operating the device

4.1	Switch on inverter	76
4.2	Switching off the inverter	77
4.3	De-energising the inverter	78
4.4	Inverter operating statuses	80
4.5	Status LEDs	81
4.6	Status display via app	83

4.1 Switch on inverter

1. Activate supply voltage via the line circuit breaker.

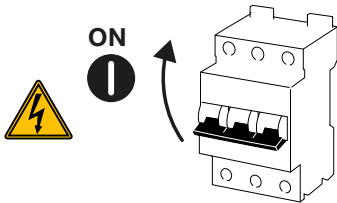

2. Move DC switch on inverter to ON position. **i**

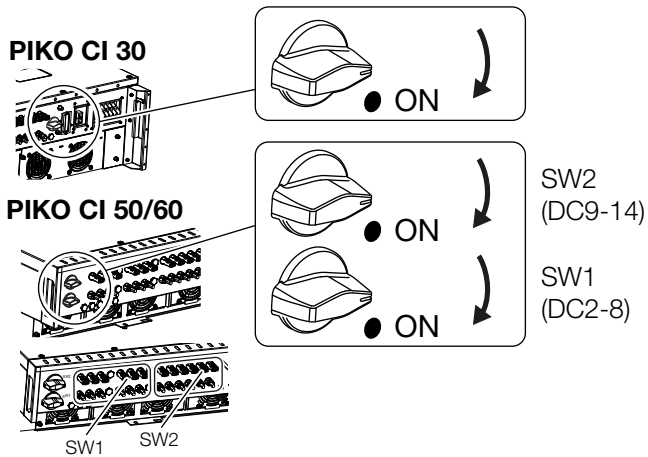

- The inverter starts up.
- The LEDs light up briefly during start-up.
- After startup, the LEDs indicate the operating status of the inverter. **i**
- ✓ The inverter is in operation.



INFO

As soon as one of the two DC switches on the PIKO 50/60 is set to ON, the inverter starts up.

The DC switch SW1 switches the DC inputs DC2-8. **Ch. 8.2**

The DC switch SW2 switches the DC inputs DC10-16. **Ch. 8.2**



INFO

When the inverter is commissioned for the first time, it goes into the *Off (Shutdown)* status.

When this happens, first carry out initial commissioning.

4.2 Switching off the inverter

In order to switch off the inverter, carry out the following steps **i** :

1. Switch off line circuit breaker.

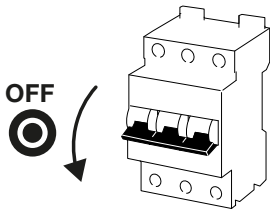

2. Switch DC switch on inverter to OFF.

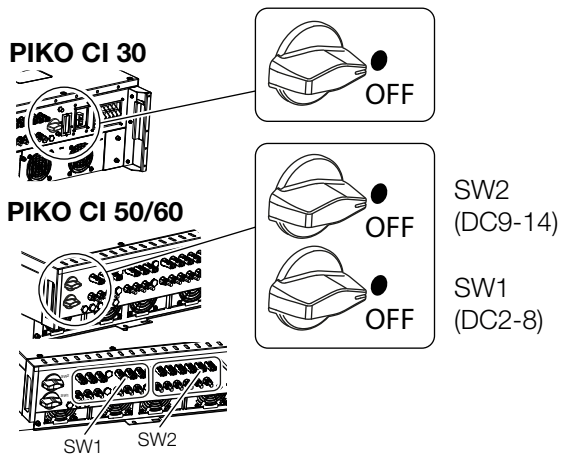

- ✓ The inverter is switched off.

The inverter remains energised and monitoring is still performed.



INFO

For maintenance work on the inverter, disconnect the unit completely.

➔ Ch. 4.3

4.3 De-energising the inverter

For maintenance work on the inverter, especially on the connections, the inverter must be disconnected from the power supply.

- For work on the AC side, e.g. on the energy meter, the earthing system or the communication connections, it is sufficient to disconnect the AC connection.
- For work on the PV modules or the DC feed lines, disconnect the DC connections.
- When working in the terminal compartment of the inverter, the inverter must be completely voltage-free on the AC and DC sides.

Disconnecting inverter on the AC side

1. Switch off AC line circuit breaker and secure it against being switched on again.

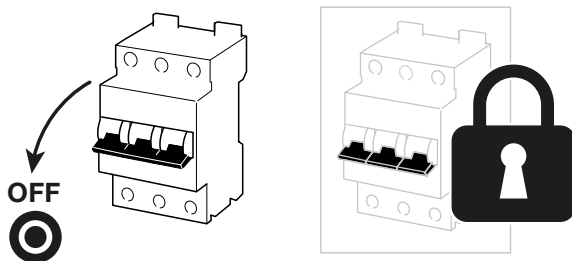

2. Switch DC switch on inverter to OFF and secure it against being switched on again.

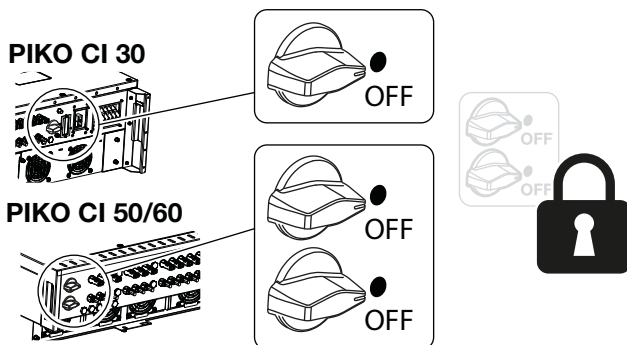

- ✓ The inverter is voltage-free on the AC side ⚠



DANGER

RISK OF DEATH DUE TO ELECTRICAL SHOCK AND DISCHARGE!

When working in the terminal compartment, on the DC supply lines or on the PV modules, the DC cables must still be disconnected.

Disconnecting DC cables

The inverter must first be de-energised on the AC side. Then all DC connections on the inverter can be disconnected. You will need the disassembly tool  supplied with the unit.

1. Insert the disassembly tool into the plug's side release openings so that the plug is unlocked and separated from the socket by approx. 1.5 mm.

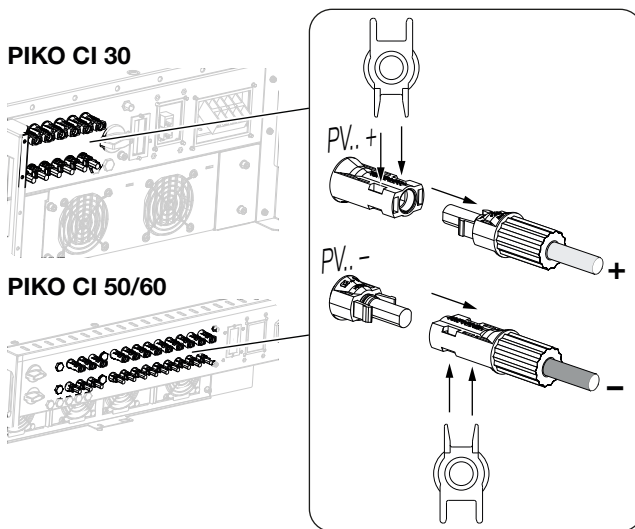

2. Remove plug from the socket.
 3. Ensure that the disconnected DC cables are protected against both weather (rain) and unauthorized access.
 4. Check that all connections on the inverter are voltage-free.
 5. Wait at least 10 minutes before carrying out any further work on the inverter so that the capacitors contained in it can discharge.
- ✓ The inverter is isolated on the DC side and voltage-free.



DANGER

RISK OF DEATH DUE TO ELECTRICAL SHOCK AND DISCHARGE!

De-energise all devices and secure them against being switched on again.

The PV generators/cables may be live as soon as they are exposed to light.

Disconnect the DC cables by interrupting the connections to the PV modules.

If it is not possible to disconnect the DC cables, observe the rules for working under voltage.

Use personal protective equipment, hard hat, visor or goggles, protective suit, insulating gloves.

Use an insulating protective mat as an underlay.

Only use insulated tools.

4.4 Inverter operating statuses

After switching on, the inverter is always in one of the following operating statuses:

Operational status	Description
Standby	The connected PV modules are not supplying enough energy to feed it into the power grid. As soon as the required conditions are met, the inverter switches to the Feed in status.
Feed in	The inverter is generating electrical energy and feeding it into the connected power grid.
Off (Shutdown)	The inverter is switched off due to a switch-off command or an error that has occurred. As soon as the inverter receives a power-up command or the error is corrected, the inverter switches to the Standby status.

4.5 Status LEDs

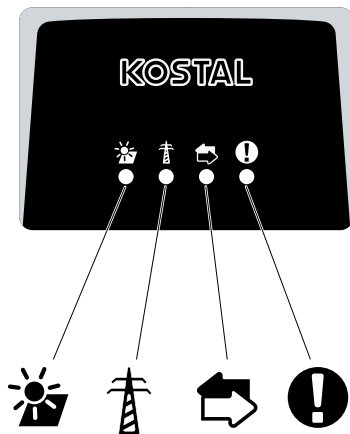





Fig. 31: Status LED

The LEDs on the front indicate the current operational status.

Further status information can be accessed using the **KOSTAL PIKO CI** app or via the **KOSTAL Solar Portal**.

Measures to rectify events can be found in the chapter **📄 Ch. 7.7**

Meaning		Status	Description
	PV inputs	Lights up	The input voltage is within the operating range
		Flashes	Overvoltage/undervoltage
	Feed-in	Off	The inverter does not feed in
		Lights up	The inverter feeds energy into the grid. Every 30 seconds the inverter reports its current power: flashes once: < 20 % flashes twice: < 40 % flashes 3 times: < 60 % flashes 4 times: < 80 % flashes 5 times: < 100 %
		Continuous flashing	The state of the power grid does not allow any feed-in.
	Communication	Off	No connection active or no communication
		Flashes	The inverter is communicating with another device
	Fault	Off	No fault
		Lights up or flashes	A fault has occurred

4.6 Status display via app

The **KOSTAL PIKO CI** smartphone app displays the current operational status, the power output and the current measured values from inverter operation: **i**



INFO

The user interface in the **KOSTAL PIKO CI** App depends on the firmware (FW) installed and the app version used and may deviate from the description provided here.

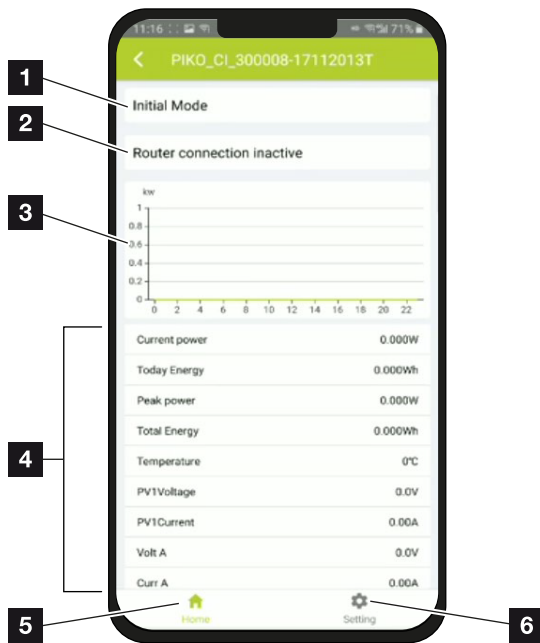

Fig. 32: Home > Operating status on app

- 1** Current operating status
- 2** Connection status to the router
- 3** Energy generated
- 4** Current measuring values
- 5** Selection of the **Home** page
- 6** Selection of the **Settings** page

Further information on the **KOSTAL PIKO CI**

➔ Ch. 5.1.

5. KOSTAL PIKO CI App

5.1	KOSTAL PIKO CI App	85
5.2	Installation of the KOSTAL PIKO CI app	86
5.3	Connecting inverters with KOSTAL PIKO CI app	87
5.4	Logging in as administrator	88
5.5	KOSTAL PIKO CI app - menu structure	89
5.6	KOSTAL PIKO CI app - menu description	93

5.1 KOSTAL PIKO CI App

The **KOSTAL PIKO CI** app, which is available free of charge, provides a graphical user interface.

The app is used to commission and configure the inverter and to display its status:

- Log in on inverter
- Log in as user or administrator
- Status request
- Current feed-in values at grid connection
- Display of the log data
- Inverter version display
- Inverter configuration
(e.g. LAN connection, setting up the energy meter, etc.)

5.2 Installation of the KOSTAL PIKO CI app

KOSTAL PIKO CI



App Store and the App Store logo are trademarks of Apple Inc., registered in the U.S. and other countries.



Google Play and the Google Play logo are trademarks of Google LLC.

Download the **KOSTAL PIKO CI** app from the Apple App Store or Google Play Store on your tablet or smartphone and install it.

5.3 Connecting inverters with KOSTAL PIKO CI app

The **KOSTAL PIKO CI** app is opened and launched via a smartphone or tablet. To do this, the smartphone or tablet must be within range of the inverter's WiFi wireless network.

1. Turn on the WiFi/WLAN function on your tablet or smartphone
 2. Call up the WiFi/WLAN settings.
 3. Switch on the inverter.
 4. Make a note of the type and serial number of the inverter you want to start up. This information can be found on the type plate.
 5. On your tablet or smartphone, find and select the WLAN network of your inverter. 
The inverter's SSID is composed of the type and serial number of the inverter.
Example: PIKO_CI_50_12345678
 6. Enter as password: **12345678** and confirm your entry. 
 7. Answer the **Check** question with **Stay**. 
 8. Launch the app.
→ The app displays the discovered inverters.
 9. Select the inverter you want to start up.
- ✓ When the app displays the message **Connect**, the inverter is connected.



INFO

If there are a lot of metal parts in the installation environment of the inverter - e.g. support frames, connecting cables, enclosures - the range of the radio connection may be impaired. Change position if you experience connection problems.



INFO

The default password is: 12345678. This should be changed after the initial commissioning.



INFO

The question does not always appear and depends on the operating system of the smartphone/tablet.

5.4 Logging in as administrator

Once the **KOSTAL PIKO CI** app is connected to an inverter, you can see all the values. However, some settings can only be changed by an administrator. This requires a change of user.

To do this, proceed as follows:

1. In the app, select the **Settings** page.
- On the **Settings** page, the app shows you various menus where you can configure settings.
2. In order to have access to all relevant settings, go to **User management** and then touch the **Change user** button.
3. Enter the password **superadmin** .
- ✓ You are now logged in as administrator.

Configuring settings

Now configure the settings of the inverter as required.



INFO

The default password for the administrator is **admin**. This can be used to configure a multitude of settings.

This password should be changed after the initial commissioning.

To configure network settings and other important settings (e.g. power limitations or network policies) you must enter the password **superadmin** when logging in as administrator. This password cannot be changed.

5.5 KOSTAL PIKO CI app - menu structure

Deviations due to software versions are possible.

Event messages

- Event messages information

Generation data

- Day/month/year energy

Basic settings

- Type
- Serial number
- Firmware version
- Internal code
- Modbus version
- Communication board version
- Update firmware
- Switch on inverter
- Switch off inverter
- Reset to factory settings
- Activate external shutdown
- Export event messages
- Export generation data
- Export configuration data
- Import configuration data
- App version

User management

- Change user
- Change login password

Communication settings

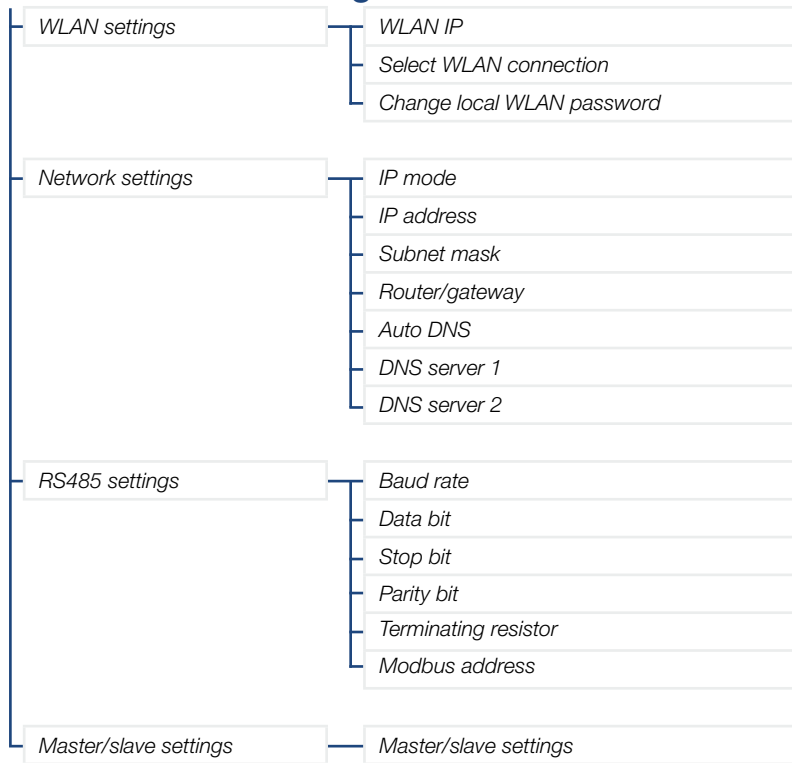

Inverter settings

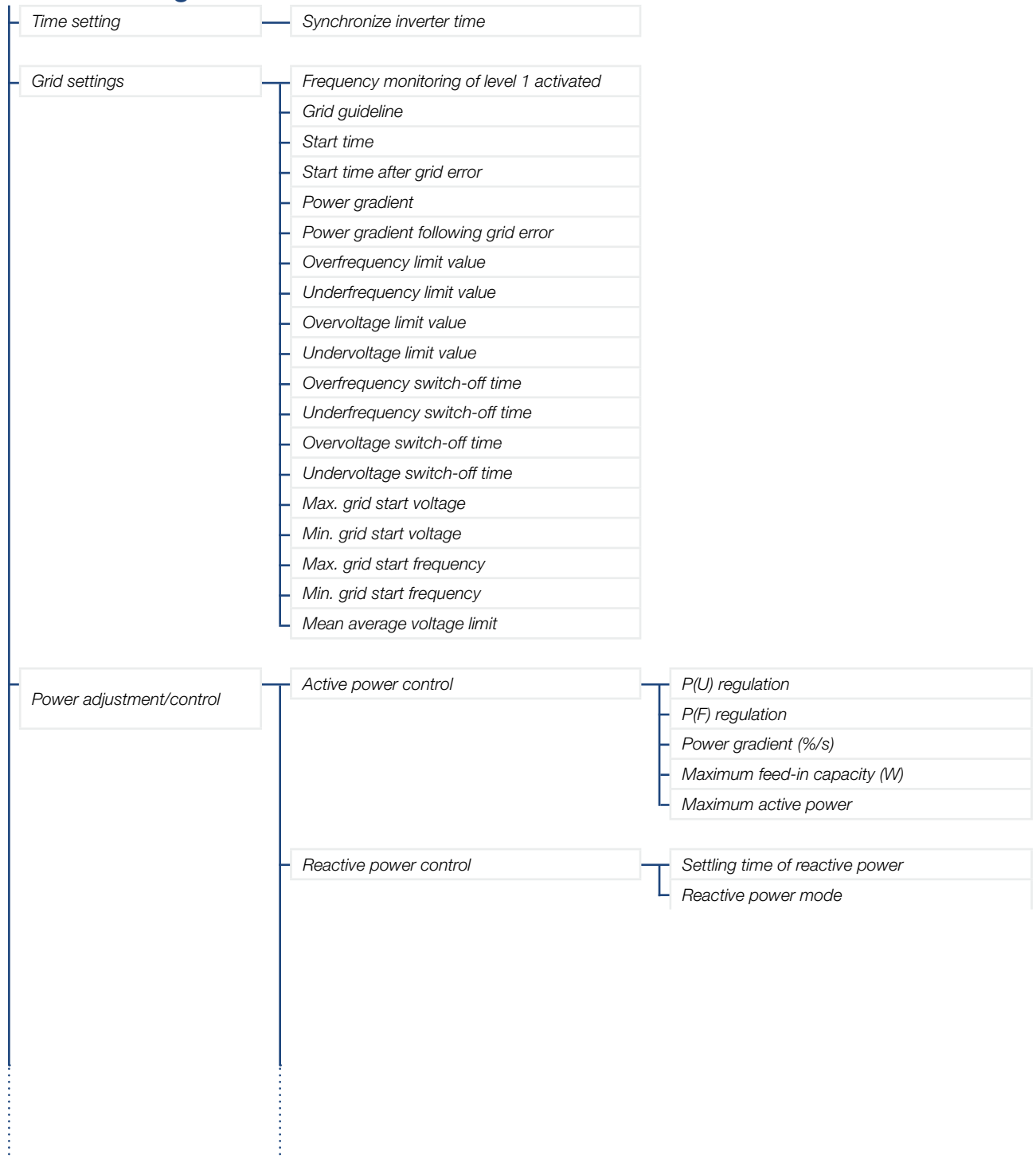

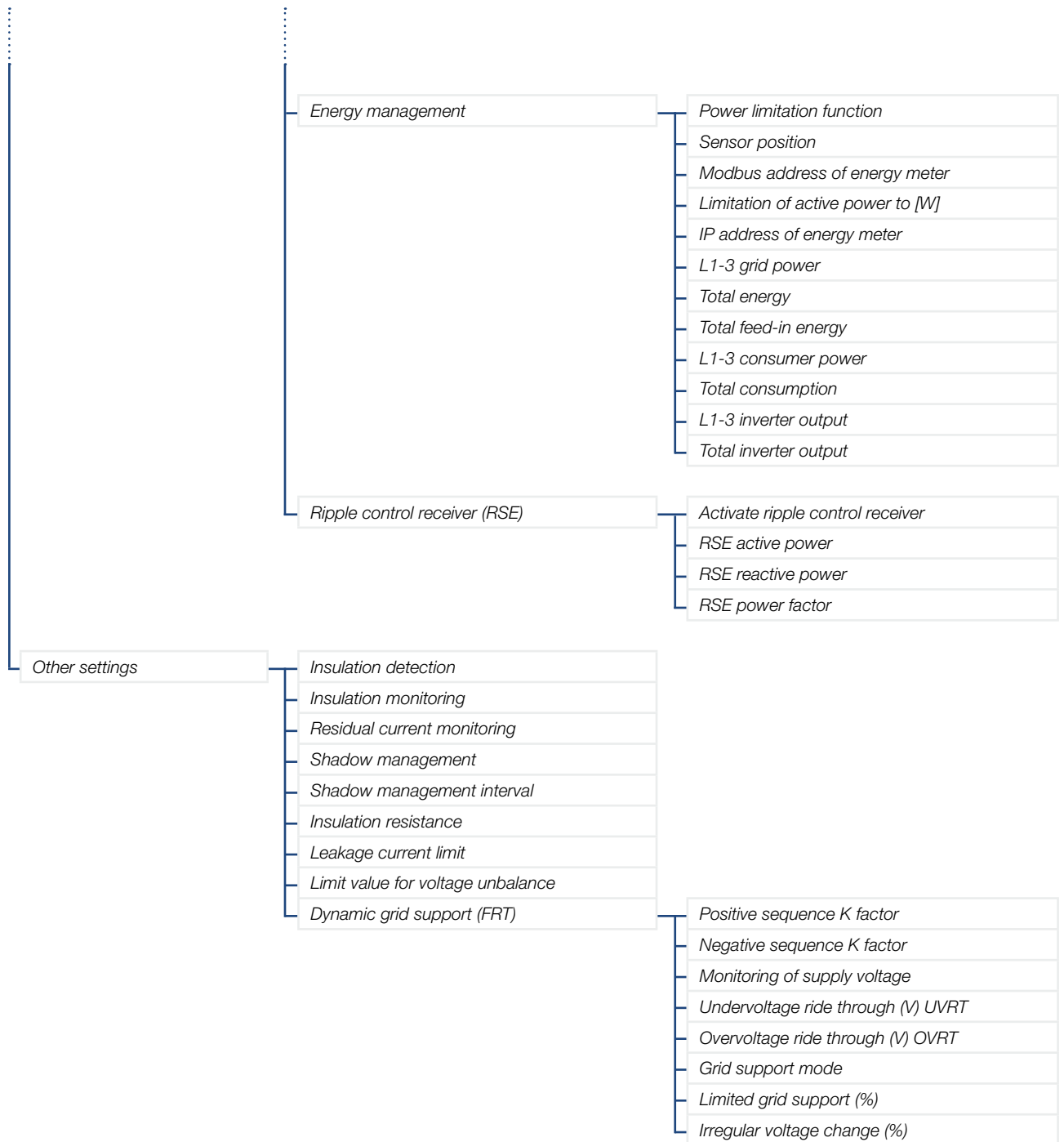

5.6 KOSTAL PIKO CI app - menu description

The following menus are available to the user in the **KOSTAL PIKO CI** app.

Home

On the Home screen, the user is shown a status overview of the inverter. This includes:

- Inverter status
- WLAN connection status between router and inverter
- Event messages
- Performance diagram
- Current measuring values

Parameter	Explanation
<i>Current power</i>	Measuring value of the electrical power currently being generated in kilowatts (kW)
<i>Today's yield</i>	Measuring value of the energy generated on the current date in kilowatt hours (kWh)
<i>Total yield</i>	Measuring value of the energy generated up to the current date
<i>Maximum power</i>	Measuring value of the highest generated power up to the current date (kW)
<i>Temperature</i>	Current ambient temperature of the inverter
<i>MPPTx voltage</i>	Measuring value of the current input voltage of PV groups 1 to 4
<i>MPPTx current</i>	Measuring value of the current input current of PV groups 1 to 4
<i>Output voltage Lx-Ly</i>	Voltage of phases L1-L3
<i>Output current Lx</i>	Current of phases L1-L3
<i>Power factor</i>	Power factor ($\cos\phi$) of the electrical power currently being output
<i>Grid frequency</i>	Output frequency of the alternating current currently being generated
<i>Active power</i>	Measuring value of the active power currently being generated
<i>Reactive power</i>	Measuring value of the reactive power currently being generated
<i>Power limitation status</i>	<i>Status / current power limitation</i>
<i>Status of ripple control receiver (RSE)</i>	<i>Status / current setting of the ripple control receiver (RCD)</i>
<i>External shutdown status</i>	Status of the central grid and system protection
<i>Power reduction status</i>	<i>Status / current power reduction</i>

Settings

These menu items can be used to retrieve inverter data and configure the inverter. These include:

- Inverter messages/events
- Generation data
- Basic information/settings
(e.g. device information, reset inverter to factory settings, export log data)
- Access management
(user administration, change password)
- Communication setting
(e.g. Ethernet (LAN)/WLAN/WiFi/RS485 settings)
- Inverter setting
(e.g. time/date, grid guidelines, etc.)



Event messages

Parameter	Explanation
<i>Event messages information</i>	Display of events in the inverter. Further information about the events and possible troubleshooting  Ch. 7.7.

Generation data

Parameter	Explanation
<i>Day/month/year energy</i>	Indication of energy generated in diagram form for day/month/year.

Basic settings

Basic information	Explanation
<i>Type</i>	Inverter model.
<i>Serial number</i>	Inverter serial number.
<i>Firmware version</i>	Safety firmware version of the inverter. Contains the security, activation and deactivation functions required for device security and network service functions.
<i>Internal code</i>	Firmware version of the controller board (CB).
<i>Modbus version</i>	MODBUS version that is used in the inverter.
<i>Communication board version</i>	Firmware version of the communication board.
<i>Update firmware</i>	Update the inverter firmware.
Operation	Explanation
<i>Switch on inverter</i>	Switch on the inverter.
<i>Switch off inverter</i>	Switch off the inverter.
<i>Reset to factory settings</i>	Reset the inverter parameters to factory settings.
<i>Activate external shutdown</i>	Activate central grid and system protection monitoring in the inverter. Further information  Ch. 5.1.
Data management	Explanation
<i>Export event messages</i>	Export log data (event messages/generation data/configuration data of the inverter)  Ch. 6.2. These are stored in the root directory on the smartphone.
<i>Export generation data</i>	
<i>Export configuration data</i>	
<i>Import configuration data</i>	Import configuration data of inverter.
About	Explanation
<i>App version</i>	Version of the KOSTAL PIKO CI app.

User management

Parameter	Explanation
<i>Change user</i>	Change the user (administrator or guest).
<i>Change login password</i>	Change administrator password. By default the password is admin . The advanced administrator password superadmin , which is required to set up the inverter or to adjust the settings of the grid parameters (e.g. power limitations or network policies), cannot be changed.

Communication settings

WLAN settings	Explanation
<i>WLAN IP</i>	WLAN IP address of the inverter WiFi module.
<i>Select WLAN connection</i>	Selection of WLAN router with password (connection of inverter to WLAN router).
<i>Change local WLAN password</i>	Change the inverter's WLAN password. By default this is 12345678
<i>Connection settings</i>	Select whether the inverter should act as a master (LAN or RS485) or slave. If set as master inverter, information or setting parameters (e.g. during power reduction) are sent to the slave inverters.

Network settings	Explanation
<i>IP mode</i>	The "Obtain IP address automatically" option is activated by default. This means that the inverter obtains its IP address from a DHCP server.
<i>IP address</i>	Enter IP address of inverter. If the inverter is not allocated an IP address automatically through a DHCP server, the inverter can be configured manually. The data necessary for configuration, such as IP, subnet mask, router and DNS addresses, can be found on your router/gateway.
<i>Subnet mask</i>	Enter the subnet mask e.g. 255.255.255.0
<i>Router/gateway</i>	Enter the IP address of the router/gateway
<i>Auto DNS</i>	The "Auto DNS" option is activated by default. This means that inverters can also be addressed using a name instead of an IP address. For this purpose, the IP addresses of the DNS servers must be entered.
<i>DNS server 1</i>	Enter the IP address of the DNS server (Domain Name System)
<i>DNS server 2</i>	Enter the IP address of the backup DNS server (Domain Name System)



RS485 settings	Explanation
<i>Baud rate</i>	RS485 transmission rate
<i>Data bit</i>	RS485 data bit
<i>Stop bit</i>	RS485 stop bit
<i>Parity bit</i>	RS485 parity bit
<i>Terminating resistor</i>	Activate terminating resistor for the RS485 bus. This must be activated on the last inverter connected to the RS485 bus.
<i>Modbus address</i>	Modbus address

Inverter settings

Time setting	Explanation
<i>Synchronize inverter time</i>	Synchronize the time of the inverter with the time of the smartphone.

The following menu items can be used to set the parameters in the inverter, which are specified by the grid operator. Parameters may only be changed on the inverter by qualified electricians who are familiar with the system and at the request of the grid operator. Inappropriate settings can be hazardous and lead to injury or even death of the user or third parties. Material damage to the device and other equipment can also occur.

Grid settings	Explanation
<i>Frequency monitoring of level 1 activated</i>	Activate/deactivate frequency monitoring level 1
<i>Grid guideline</i>	Select grid guideline (e.g. VDE-AR-N 4105)
<i>Start time</i>	Start-up waiting time after switching on the inverter
<i>Start time after grid error</i>	Start-up time following inverter grid error
<i>Power gradient</i>	Power gradient after switching on the inverter
<i>Power gradient following grid error</i>	Power gradient following inverter grid error
<i>Overfrequency limit value</i>	Set overfrequency limit threshold value
<i>Underfrequency limit value</i>	Set underfrequency protection threshold value
<i>Overvoltage limit value</i>	Set overvoltage protection limit value
<i>Undervoltage limit value</i>	Set undervoltage protection limit value
<i>Overfrequency switch-off time</i>	Set overfrequency switch-off time
<i>Underfrequency switch-off time</i>	Set underfrequency shut-off time
<i>Overvoltage switch-off time</i>	Set overvoltage switch-off time
<i>Undervoltage switch-off time</i>	Set undervoltage switch-off time
<i>Max. grid start voltage</i>	If the supply voltage is higher than the upper limit of the reconnection voltage after the inverter has been shut down for protection due to a fault, the inverter may not be reconnected to the grid.
<i>Min. grid start voltage</i>	After the inverter is shut down for protection due to a fault, if the supply voltage is lower than the lower limit of the reconnection voltage, the inverter may not be reconnected to the grid.
<i>Max. grid start frequency</i>	After the inverter is shut down for protection due to a fault, if the grid frequency is higher than the upper limit of the reconnection frequency, the inverter may not be reconnected to the grid.
<i>Min. grid start frequency</i>	After the inverter is shut down for protection due to a fault, if the grid frequency is lower than the lower limit of the reconnection frequency, the inverter may not be reconnected to the grid.
<i>Mean average voltage limit</i>	Set 10 minutes of average overvoltage value

Power adjustment/control		Explanation
Active power control		Active power control
	<i>P(U) regulation</i>	Parameter of the P(U) curve, which reduces active power if the output voltage exceeds a certain value
	<i>P(F) regulation</i>	Set the inverter's maximum active power
	<i>Power gradient (%/s)</i>	Parameter of the P(U) curve, which reduces active power if the output voltage exceeds a certain value
	<i>Maximum feed-in capacity (W)</i>	Parameter of the P(f) curve, which decreases active power during overfrequency or increases active power during underfrequency
	<i>Maximum active power</i>	Configure settings according to the power supply company for active power control.
Reactive power control		Reactive power control
	<i>Settling time of reactive power</i>	Specifies the reactive power settling time (3 Tao, PT-1 behaviour)
	<i>Reactive power mode</i>	Specifies the reactive power control mode. Configure settings according to the power supply company for reactive power control.
Energy management		Power limitation
	<i>Power limitation function</i>	Deactivated: No energy meter connected to the inverter. KSEM: A KOSTAL Smart Energy Meter is connected to the inverter.
	<i>Energy meter position</i>	Installation position of energy meter (grid connection point or consumer)  Ch. 3.11
	<i>Modbus address of energy meter</i>	Energy meter Modbus address
	<i>Limitation of active power to [W]</i>	Set up power limitation
	<i>IP address of energy meter</i>	Energy meter IP address
	<i>L1-3 grid power</i>	Displays the grid power at the individual phases
	<i>Total energy</i>	Shows the energy supply from the public grid
	<i>Total feed-in energy</i>	Shows the feed-in into the public grid
	<i>L1-3 consumer power</i>	Shows the consumer power at the individual phases
	<i>Total consumption</i>	Shows the total consumption
	<i>L1-3 inverter output</i>	Shows the inverter output at on the individual phases
	<i>Total inverter output</i>	Shows the total energy generated by the inverter
Ripple control receiver (RSE)		Ripple control receiver control
	<i>Activate ripple control receiver</i>	Activate/deactivate ripple control receiver function  Ch. 3.13
	<i>RSE active power</i>	Set active power value for ripple control receiver
	<i>RSE reactive power</i>	Set reactive power value for ripple control receiver
	<i>RSE power factor</i>	Set power factor for ripple control receiver

Other settings	Explanation									
<i>Insulation detection</i>	Activate/deactivate isolated network detection									
<i>Insulation monitoring</i>	Activate/deactivate insulation detection function. When enabled, the inverter detects the insulation resistance before it is connected to the grid.									
<i>Residual current monitoring</i>	Activate/deactivate residual current monitoring. When the function is enabled, the inverter detects the array fault current.									
<i>Shadow management</i>	Shadow management If PV strings are in partial shading, the PV string affected no longer achieves its optimum performance. If shadow management is activated, the inverter adapts the MPP tracker in such a way that it can operate at maximum possible performance.									
<i>Shadow management interval</i>	Set the interval of the MPP tracker sampling rate									
<i>Insulation resistance</i>	If the value established for insulation resistance is less than the preset value, the inverter is not connected to the grid									
<i>Leakage current limit</i>	Limit value for leakage current detection. If the value established is higher than the preset value, the inverter will shut down.									
<i>Limit value for voltage unbalance</i>	Set threshold value for mains voltage unbalance									
<i>Dynamic grid support (FRT)</i>	<i>Dynamic grid support (FRT = Fault Ride Through)</i>									
<table border="1"> <tr> <td data-bbox="204 1193 571 1234"><i>Positive sequence K factor</i></td> <td data-bbox="571 1193 1482 1568" rowspan="9">Settings for the uninterrupted ride through of grid faults FRT (Fault Ride Through)</td> </tr> <tr> <td data-bbox="204 1234 571 1274"><i>Negative sequence K factor</i></td> </tr> <tr> <td data-bbox="204 1274 571 1314"><i>Monitoring of supply voltage</i></td> </tr> <tr> <td data-bbox="204 1314 571 1384"><i>Undervoltage ride through (V) UVRT</i></td> </tr> <tr> <td data-bbox="204 1384 571 1453"><i>Overvoltage ride through (V) OVRT</i></td> </tr> <tr> <td data-bbox="204 1453 571 1494"><i>Grid support mode</i></td> </tr> <tr> <td data-bbox="204 1494 571 1534"><i>Limited grid support (%)</i></td> </tr> <tr> <td data-bbox="204 1534 571 1574"><i>Irregular voltage change (%)</i></td> </tr> </table>	<i>Positive sequence K factor</i>	Settings for the uninterrupted ride through of grid faults FRT (Fault Ride Through)	<i>Negative sequence K factor</i>	<i>Monitoring of supply voltage</i>	<i>Undervoltage ride through (V) UVRT</i>	<i>Overvoltage ride through (V) OVRT</i>	<i>Grid support mode</i>	<i>Limited grid support (%)</i>	<i>Irregular voltage change (%)</i>	
<i>Positive sequence K factor</i>	Settings for the uninterrupted ride through of grid faults FRT (Fault Ride Through)									
<i>Negative sequence K factor</i>										
<i>Monitoring of supply voltage</i>										
<i>Undervoltage ride through (V) UVRT</i>										
<i>Overvoltage ride through (V) OVRT</i>										
<i>Grid support mode</i>										
<i>Limited grid support (%)</i>										
<i>Irregular voltage change (%)</i>										

6. System monitoring

6.1	The log data	101
6.2	Interrogating log data	102
6.3	The KOSTAL Solar Portal	104

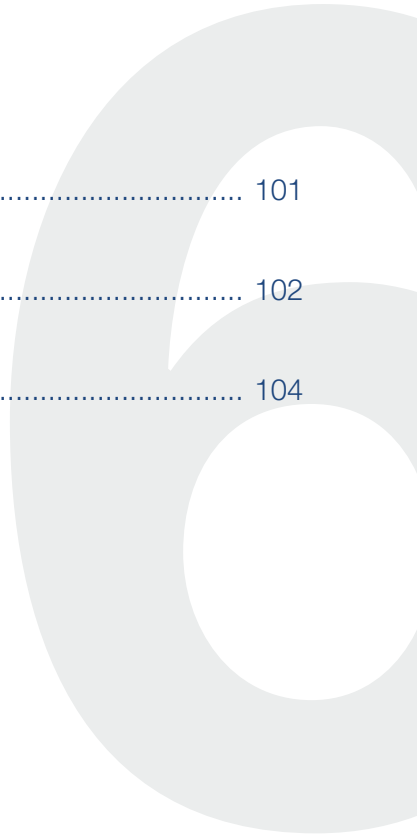

6.1 The log data

The inverter is equipped with a data logger, which regularly records data from the system. The log data can be used for the following purposes:

- Check operating characteristics of the system
- Determine and analyse errors
- Download and graphically depict yield data

6.2 Interrogating log data

There are several variants for retrieving and permanently saving the log data:

- **Variant 1:** Download and display log data via the **KOSTAL PIKO CI** app
- **Variant 2:** Transfer log data to a solar portal and display it

Variant 1: Download the log data with a computer and display it

A range of inverter data can be exported.

- Event messages
 - Generation data
 - Inverter configuration data
1. In the **KOSTAL PIKO CI** app, go to "**Settings > Basic settings > Export event messages**".
 Ch. 5.5
 2. Confirm the download.
- ✓ The log data can be saved to a computer and displayed and further processed with any common program for calculating spreadsheets (e.g. Excel).

Variant 2: Transferring log data to the KOSTAL Solar Portal and displaying it

With a solar portal it is possible to monitor the PV system and performance data via the Internet.

The **KOSTAL Solar Portal** has the following functions. However, they may differ depending on the portal:

- Graphic depiction of performance data
- Worldwide online access to the portal
- Email notification of errors
- Data export (e.g. Excel file)
- Long-term storage of log data

Data transmission to the KOSTAL Solar Portal:

- ✓ The inverter has an Internet connection
- ✓ The inverter is registered on the **KOSTAL Solar Portal**
- ✓ The activation of data transmission is activated in the inverter by default



INFO

A correctly set-up network connection/Internet connection is a prerequisite for data transfer

It may take as long as 20 minutes following activation before the data export is visible on the **KOSTAL Solar Portal**.

The **KOSTAL Solar Portal** can be accessed via the following link:
www.kostal-solar-portal.com

6.3 The KOSTAL Solar Portal

The solar portal, provided by KOSTAL Solar Electric GmbH, is a free Internet platform for monitoring PV systems.

The inverter sends the PV system's yield data and event messages to the **KOSTAL Solar Portal** via the Internet.

The information is then stored in the **KOSTAL Solar Portal**. You can view and call up this information via the Internet.

Conditions for use

- The inverter must have a connection to the Internet.
- The inverter must not yet be registered on the **KOSTAL Solar Portal**.
- The inverter must not yet be assigned to a plant.

To use the solar portal, follow these two steps:

- Data transmission to the **KOSTAL Solar Portal** must be activated in the inverter. With the PIKO CI, this activation is activated by default.
- To use the **KOSTAL Solar Portal** you must sign up for a free account on the KOSTAL Solar Electric GmbH website.

7. Maintenance

7.1	During operation	106
7.2	Maintenance and cleaning	107
7.3	Housing cleaning	108
7.4	Fan	109
7.5	Replacing PV fuse	110
7.6	Updating software	111
7.7	Event codes	112

7.1 During operation

Once correctly installed, the inverter runs virtually maintenance-free.

For proper operation in a larger solar system, the normal measures of regular system monitoring are fully sufficient.

In particular, tracking the energy obtained via data loggers, the **KOSTAL Solar Portal** or energy meters will quickly indicate irregularities. Events during operation are also logged.

For plant safety, we would recommend the maintenance work stated in the following sections.

7.2 Maintenance and cleaning

The following maintenance tasks are to be carried out for the inverter: ⚠

Activity	Interval
Check operational status - normal operating noise - function of all communication connections - damage or housing deformation	once a month
Electrical connections - check that cable connections and plugs have good contact and are secure - check cable connections for damage or ageing - check grounding	once every six months
Clean the inverter - remove soiling - check ventilation ducts, clean if necessary - remove and clean the fan if necessary	once a year

Tab. 2: Maintenance list

Use maintenance lists in which the work undertaken is logged.

If no maintenance work is carried out, this will result in an exclusion of warranty (see 'Exclusion of warranty' in our Service and warranty conditions).



DANGER

RISK OF DEATH DUE TO ELECTRICAL SHOCK AND DISCHARGE!

Life-threatening voltages are present in the inverter. Only a qualified electrician may open and perform work on the device.

Disconnect all poles of the device before starting work.

Wait at least 10 minutes after disconnecting the unit until the internal capacitors have discharged.

7.3 Housing cleaning

Only clean the housing with a damp cloth.

Do not use any harsh cleaning agents.

Do not use devices that produce a spray or water jet.

In particular, check the condition of the ventilation ducts and the function of the fans.

7.4 Fan

Inverters generate heat during operation, which is dissipated via built-in heat sinks and fans. For this purpose, the ventilation ducts and fans must be kept free of contamination.

If problems occur, check whether the ambient temperature of the inverter exceeds the upper limit. If so, improve ventilation to lower the temperature. If the fan emits abnormal noise, replace the corresponding fans in good time. Please contact your support team for assistance with this.

Vacuuming ventilation ducts

To ensure many years of trouble-free operation, regularly vacuum the ventilation ducts. 

- Remove detritus consisting of leaves, dust, insects, etc., especially in the vicinity of the ventilation ducts.
- For example, use an industrial vacuum cleaner and vacuum the ventilation ducts and immediate surroundings.



DAMAGE POSSIBLE

Risk of damage when blowing out with compressed air.

When blowing out the ventilation ducts with compressed air, fine dust particles may find their way into the bearings of the installed fans and damage them.

Do not use compressed air, vacuum the inverter's ventilation ducts instead.

7.5 Replacing PV fuse

The PV fuse in the PIKO CI 50/60 can be replaced. If an event prompting this is displayed, the inverter must be disconnected from the grid on the DC and AC sides.

1. Inverter on DC and AC sides voltage-free
▣ **Ch. 4.3.** 
2. Wait at least 10 minutes after the inverter has been switched off.
3. Open the lower section of the inverter.

PIKO CI 50/60

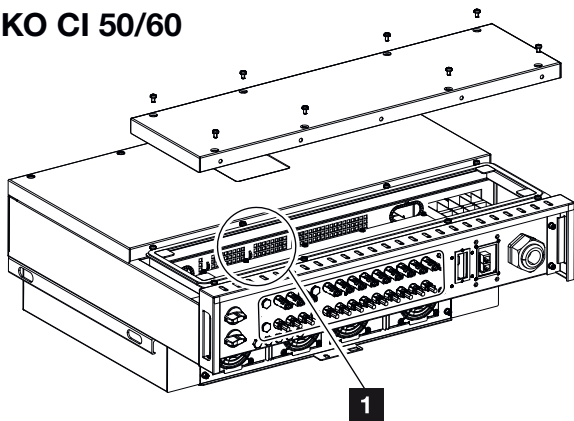

Fig. 33: PIKO CI 50/60 inverter (PV fuses)

- ▣ PV fuses
4. Use a multimeter to identify and replace defective fuses.
5. Install cover and screw it tight (1.5 Nm).
6. Switch on the inverter again.
- ✓ The PV fuses have been replaced.



DANGER

RISK OF DEATH DUE TO ELECTRICAL SHOCK AND DISCHARGE!

Life-threatening voltages are present in the inverter. Only a qualified electrician may open and perform work on the device.

Disconnect all poles of the device (AC and DC side) before starting work.

Wait at least 10 minutes after disconnecting the unit until the internal capacitors have discharged.

7.6 Updating software

If the manufacturer has updated software for the inverter, this can be loaded into the inverter. The software is updated to the latest version. If an update is available, you will find this on the manufacturer's website, in the download area.

Procedure

Use a smartphone or tablet with the **KOSTAL PIKO CI** app installed. Proceed as follows:

1. Download the inverter update from the manufacturer's website to your smartphone/tablet.
2. Launch the app on your smartphone or tablet that you are using for commissioning.
3. Establish the connection between the smartphone/tablet and your inverter.
4. Go to **Settings > Basic Settings > Firmware Upgrade** and search for the update on your smartphone or tablet.
 - The inverter recognises the update file and starts the installation.
5. If you want to install the update, confirm with OK.
 - The update is installed. The inverter is then restarted. The update may take up to 10 minutes.
 - After the update, the app shows the successful installation.
6. In the app, check the version of the software.
7. Log the update and software version.
- ✓ The update has been installed.

7.7 Event codes

There is no need to take action when an event occurs occasionally or only briefly and the device resumes operation. When an event occurs over long periods or recurs frequently, the cause must be determined and rectified. ⚠️

In case of a permanent event, the inverter interrupts the feed-in and switches off automatically.

- Check whether the DC switch or the external DC voltage separator has been switched off.
- Check whether the event is due to a mains power failure, or whether the fuse between the feed meter and the inverter has tripped.

In case of fuse failure, notify your installer. In the event of a power failure, wait until the grid operator has rectified the fault.

If the event lasts only a short time (grid fault, overheating, overload, etc.), then the inverter will automatically resume operation as soon as the event has been resolved.

If the event persists, notify your installer or the manufacturer's customer support team. ⓘ

Provide the following information:

- Device type and serial number. You will find this information on the type plate on the exterior of the housing.
- Error description (LED display and message in the **KOSTAL PIKO CI** app).



DANGER

RISK OF DEATH DUE TO ELECTRICAL SHOCK AND DISCHARGE!

Life-threatening voltages are present in the inverter. Only a qualified electrician may open and perform work on the device.



INFO









You can find contact details in the chapter "Warranty and service":

📄 **Ch. 10.2**









































Operating statuses and error causes are reported as a combination of LED display and event code. The event code is shown in the **KOSTAL PIKO CI** app or in the **KOSTAL Solar Portal**. Determine the type of event using the table below.

































































































If an event occurs repeatedly or permanently, or for events that are not listed in the table, please contact Service.













Key for LEDs / display

-  LED lights up
-  Status of PV modules
-  LED flashes
-  Status of grid
-  Original status
-  Status of communication
-  LED off
-  Warning message/alarm

Event messages

Event code portal	Event code inverter	Meaning	LED			
						
-	-	Status normal				
-	-	Commissioning/start-up				
-	-	WLAN / WiFi / RS485 communication				
-	-	PV normal				
30001	A0	Grid overvoltage				
30002	A1	Grid undervoltage				
30003	A2	Grid missing				
30004	A3	Grid overfrequency				
30005	A4	Grid underfrequency				

Event code portal	Event code inverter	Meaning	LED			
						
30006	B0	PV overvoltage				
30007	B1	PV Insulation fault				
30008	B2	Leakage current fault				
30010	C0	Control power low				
30011	B3	PV string error				
30012	B4	PV undervoltage				
30013	B5	Weak PV irradiation				
30014	A6	Grid error				
30017	C2	Grid DC current share too high				
30018	C3	Inverter relay fault				
30020	C5	Inverter overtemperature				
30021	C6	Residual current monitoring fault				
30022	B7	Reverse polarity strings				
30023	C7	System error				
30024	C8	Fan blocked				
30025	C9	DC link unbalance				
30026	CA	Overvoltage of intermediate circuit				
30027	CB	Internal communication error				
30028	CC	Software incompatible				
30029	CD	Inverter EEPROM error				
30030	CE	Persistent warning				
30031	CF	Inverter error				
30032	CG	DC booster error				

Event code portal	Event code inverter	Meaning	LED			
						
30038	CH	Master connection lost				
30039	CJ	Meter connection lost				

Tab. 3: Event codes

If the inverter enters shutdown mode due to an event shown above, the Warning/Alarm LED will light up. The Troubleshooting table describes actions to be taken for the most common events.

Troubleshooting

Event code	Causes	Recommended measures
Grid overvoltage	The grid voltage exceeds its permissible range or the grid is not available.	If the alarm occurs occasionally, there may be a fault in the power supply system. No additional measures are required. If the alarm occurs repeatedly, contact your local power company. If the fault is not due to the grid, check the grid settings of the inverter using the KOSTAL PIKO CI app. If the alarm persists for a long time, check whether the AC line circuit breaker / AC terminals are disconnected or the grid power supply has failed.
Grid undervoltage		
Grid missing		
Grid overfrequency		
Grid underfrequency		
Grid error		
PV overvoltage	The input voltage of the PV modules exceeds the permissible range of the inverter.	Check the number of PV modules and adjust them if necessary.
PV undervoltage	The input voltage of PV modules is below the preset protection value of the inverter.	When the intensity of the sunlight is low, the voltage of the PV modules drops. No action is required. If the intensity of sunlight is high, check for short circuits, open circuits, etc. in the PV strings.
PV insulation fault	There is a short circuit between PV strings and protective earth. PV strings are installed in a persistently humid environment.	If the alarm occurs accidentally, the external circuits (PV strings) will supply irregular values. The inverter automatically returns to normal operation after the fault has been corrected. If the alarm occurs repeatedly or lasts for a long time, check whether the insulation resistance of the PV strings to earth is too low.

Event code	Causes	Recommended measures
Leakage current error	The insulation resistance to earth on the input side decreases during inverter operation, resulting in too high a residual current.	Check the insulation resistance to earth for the PV strings. If a short circuit has occurred, correct the error. If the insulation resistance to earth in a rainy environment is less than the default value, set the insulation resistance protection to SE Touch.
Weak PV irradiation	PV strings have been covered for a long time. PV strings deteriorate.	Check whether the PV string is covered. If the PV string is clean and not covered, check if the PV modules are ageing or if the performance has deteriorated.
PV string error	The cables of the PV strings were connected the wrong way round during inverter installation.	Check that the PV string cables are correctly connected. If they are connected the wrong way round, connect the cables correctly.
BUS undervoltage	An unusual internal imbalance in relation to the energy control was caused by the PV strings, which triggered a major change in working conditions in the grid.	If the alarm occurs occasionally, the inverter can automatically return to normal operation after the fault has been corrected.
BUS overvoltage		
Reverse polarity strings		If the alarm occurs repeatedly, contact your support team for technical assistance.
DC booster error		
EEPROM error	EEPROM component damaged	Please contact your support team. Replace the monitoring card.
Zero power generation and yellow alarm light, which lights up in the remote monitoring system	Communication failure	If a data logger is being used, modern or otherwise, please restart the data logger. If the error still occurs, contact your support team.
Remote monitoring system indicates zero power generation	Communication failure	If a data logger is being used, modern or otherwise, please restart the data logger. If the error still occurs, contact your support team.
Remote monitoring system shows no output voltage	DC switch to OFF	Check if the DC switch is damaged, and if not, turn it ON. If the error still occurs, contact your support team.
Grid error	Fault in the power supply system	Wait until power is restored.
	DC switch to OFF	Turn the DC switch to ON. If the DC switch trips frequently, contact your support.
Master connection lost	Connection between slave and master inverter is interrupted.	Check whether the communication line to the master inverter has been interrupted. If the error still occurs, contact your support team. Check the communication settings in the KOSTAL PIKO CI app.

Event code	Causes	Recommended measures
Meter connection lost	Communication connection to energy meter (KSEM) interrupted	Check whether the communication line between the master inverter and energy meter (KSEM) has been interrupted. If the error still occurs, contact your support team. Check the communication settings in the KOSTAL PIKO CI app.

Tab. 4: Troubleshooting

8. Technical data

8.1	Technical data	119
8.2	Block diagrams	123

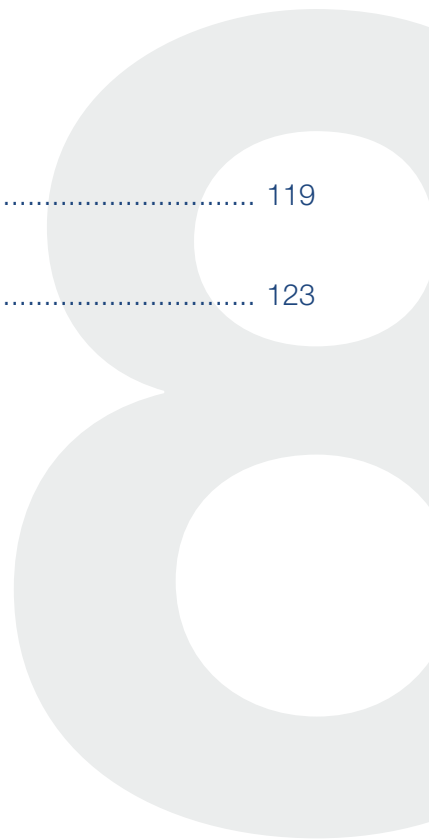

8.1 Technical data

Subject to technical changes. Errors excepted.

You can find current information at www.kostal-solar-electric.com.

Power class		30	50	60
Input side (DC)				
Max. PV power ($\cos \varphi = 1$)	kWp	45	75	90
Nominal DC power	kW	30	50	60
Rated input voltage	V	620	620	620
Start input voltage	V	250	250	250
Input voltage ($U_{DCmin} \dots U_{DCmax}$)	V	180 ... 1000	200 ... 1100	200 ... 1100
MPP range at rated power ($U_{MPPmin} \dots U_{MPPmax}$)	V	480 ... 800	540 ... 800	540 ... 800
MPP working voltage range ($U_{MPPworkmin} \dots U_{MPPworkmax}$)	V	180 ... 960	200 ... 960	200 ... 960
Max. working voltage ($U_{DCworkmax}$)	V	960	960	960
Max. input current (I_{DCmax}) per MPPT	A	DC1-3: 37.5 DC4-6: 37.5	DC1-3: 33 DC4-6: 33 DC7-8: 22 DC9-10: 22	DC1-3: 33 DC4-6: 33 DC7-9: 33 DC9-12: 33
Max. PV short-circuit current ($I_{SC_{PV}}$)	A	90 (45/45)	150 (45/45/30/30)	180 (45/45/45/45)
Max. DC current per DC plug	A	14	14	14
Number of DC inputs		6	10	12
Number of independent MPP trackers		2	4	4
Output side (AC)				
Rated output, $\cos \varphi = 1$ ($P_{AC,r}$)	kW	30	50	60
Max. output apparent power, $\cos \varphi_{adj}$	kVA	33	55	66
Min. output voltage (U_{ACmin})	V	277	277	277
Max. output voltage (U_{ACmax})	V	520	520	520
Rated output current	A	48	83	90
Max. output current (I_{ACmax})	A	48	83	92
Short-circuit current (peak / RMS)	A	48	83	92
Grid connection		3N~, 400 V, 50/60 Hz		

Power class		30	50	60
Rated frequency (fr)	Hz	50/60		
Grid frequency ($f_{\min} - f_{\max}$)	Hz	47/52.5		
Setting range of the power factor $\cos \varphi_{AC,r}$		0.8...1...0.8		
Power factor for rated power ($\cos \varphi_{AC,r}$)		1		
Max. THD	%	3		
Device properties				
Standby (night-time consumption)	W	< 1		
Efficiency				
Max. efficiency	%	98.2	98.3	98.3
European efficiency	%	97.9	98.1	98.1
MPP adjustment efficiency	%	99.9	99.9	99.9
System data				
Topology: Without galvanic isolation – transformerless		✓		
Protection class in accordance with IEC 60529		IP 65		
Protective class in accordance with IEC 62103		I		
Overvoltage category according to IEC 60664-1 input side (PV generator) ¹		II		
Overvoltage category according to IEC 60664-1 output side (grid connection) ²		III		
DC/AC overvoltage protection		Type 2		
Degree of contamination ³		4		
Environmental category (outdoor installation)		✓		
Environmental category (indoor installation)		✓		
UV resistance		✓		
AC cable diameter (min-max)	mm	22 ... 32	35 ... 50	
AC conductor cross section (min-max)	mm ²	10 ... 25	35 ... 50	

Technical data

Power class		30	50	60
DC conductor cross section (min-max)	mm ²	4 ... 6		
Max. fuse protection on output side according to IEC 60898-1		B63/C63	B125 / C125	B125 / C125
Internal operator protection in accordance with EN 62109-2		RCMU/RCCB type B		
Independent disconnection device according to VDE V 0126-1-1		✓		
Height / width / depth	mm	470/555/270	710/855/285	
Weight	kg	41	83	
Cooling principle – regulated fans		✓		
Max. air throughput	m ³ /h	185	411	
Noise emission (typical) ⁴	dB(A)	50	< 63	
Ambient temperature	°C	-25 ... +60		
Max. operating altitude above sea level	m	4000		
Relative humidity	%	0...100		
Connection technology, DC side		Amphenol plug H4		
Connection technology on AC-side (stud)		M6	M8	
Interfaces				
Ethernet LAN TCP/IP (RJ45)		2		
WLAN		✓		
RS485		1		
Digital inputs		4		
Warranty				
KOSTAL Smart Warranty / Warranty	Years	5 (2)		
Directives / Certification				
EN 62109-1, EN 62109-2, VDE AR-N 4105:2018, PO 12.2, RD 244:2019, UNE 217001, EN 50549-1-2, CEI0-16 2019, CEI0-21 2019 >11,08 kW, UK G99/1-4 LV, IRR-DCC MV 2015, IEC 61727/62116				

¹ Overvoltage category II (DC input): The device is suitable for connection to PV strings. Long feed cables out of doors or a lightning protection system in the vicinity of the PV system may make lightning protection or surge protection equipment necessary.

² Overvoltage category III (AC output): The device is suitable for permanent connection in the grid distribution behind the meter and the line protection fuse. If the connection cable travels outdoors over long distances, overvoltage protection devices may be necessary.

³ Contamination degree 4: Contamination results in continuous conductivity, e.g. due to conductive dust, rain or snow; indoors or outdoors.

⁴ Measured under rated output at an ambient temperature of 23 °C. In the case of an unfavourable string connection or higher ambient temperature, the noise emission may be higher.

8.2 Block diagrams

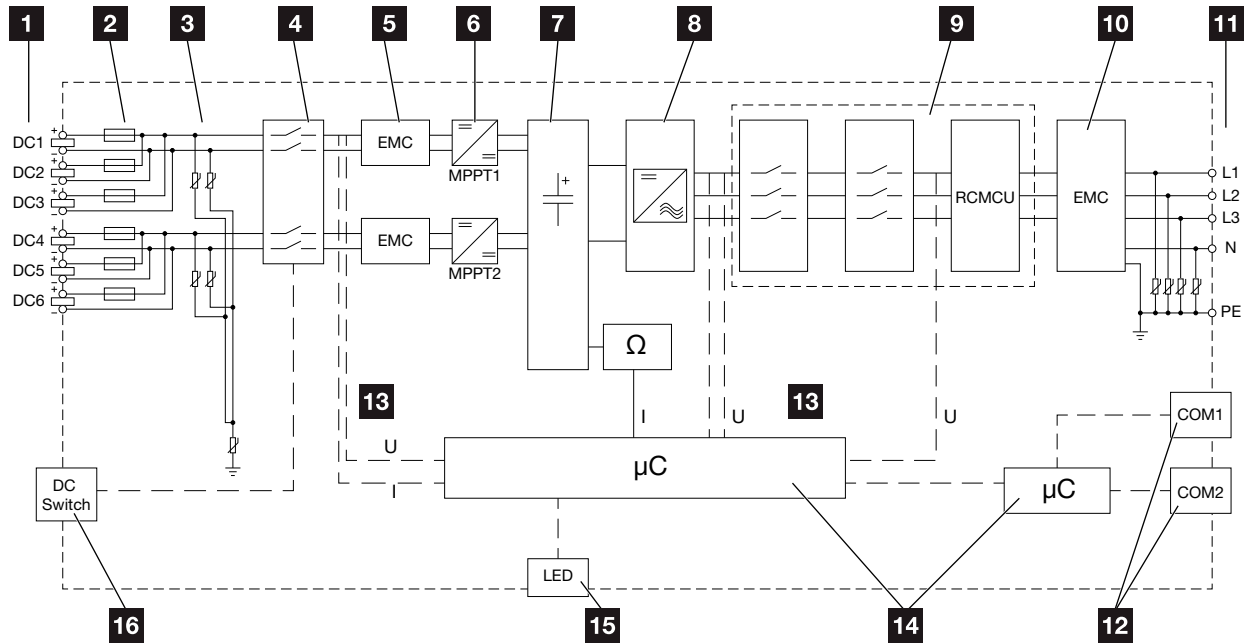

Fig. 34: Block diagram for PIKO CO 30

- 1** DC inputs for PV modules
- 2** DC fuses
- 3** Integrated overvoltage protection (DC side)
- 4** Electronic DC disconnection device
- 5** EMC filter (DC side)
- 6** DC regulator
- 7** Intermediate circuit
- 8** Inverter bridge circuit
- 9** Grid monitoring and shut-down
- 10** EMC filter (AC side)
- 11** AC connection
- 12** COM1 and COM2 connection panels for communication interfaces
- 13** Voltage and current measurement
- 14** Control system and communication
- 15** Status LED
- 16** DC switch

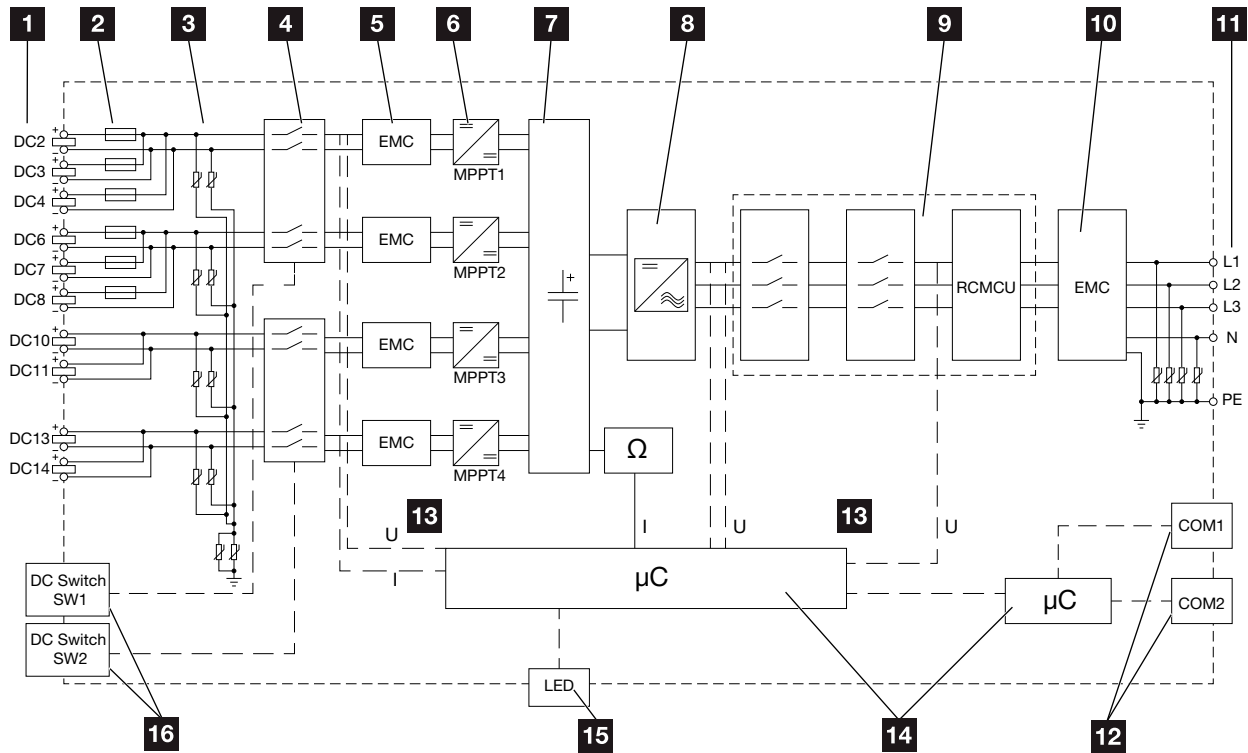

Fig. 35: Block diagram for PIKO CI 50

- 1** DC inputs for PV modules
- 2** DC fuses
- 3** Integrated overvoltage protection (DC side)
- 4** Electronic DC disconnection device
- 5** EMC filter (DC side)
- 6** DC regulator
- 7** Intermediate circuit
- 8** Inverter bridge circuit
- 9** Grid monitoring and shut-down
- 10** EMC filter (AC side)
- 11** AC connection
- 12** COM1 and COM2 connection panels for communication interfaces
- 13** Voltage and current measurement
- 14** Control system and communication
- 15** Status LED
- 16** DC switch

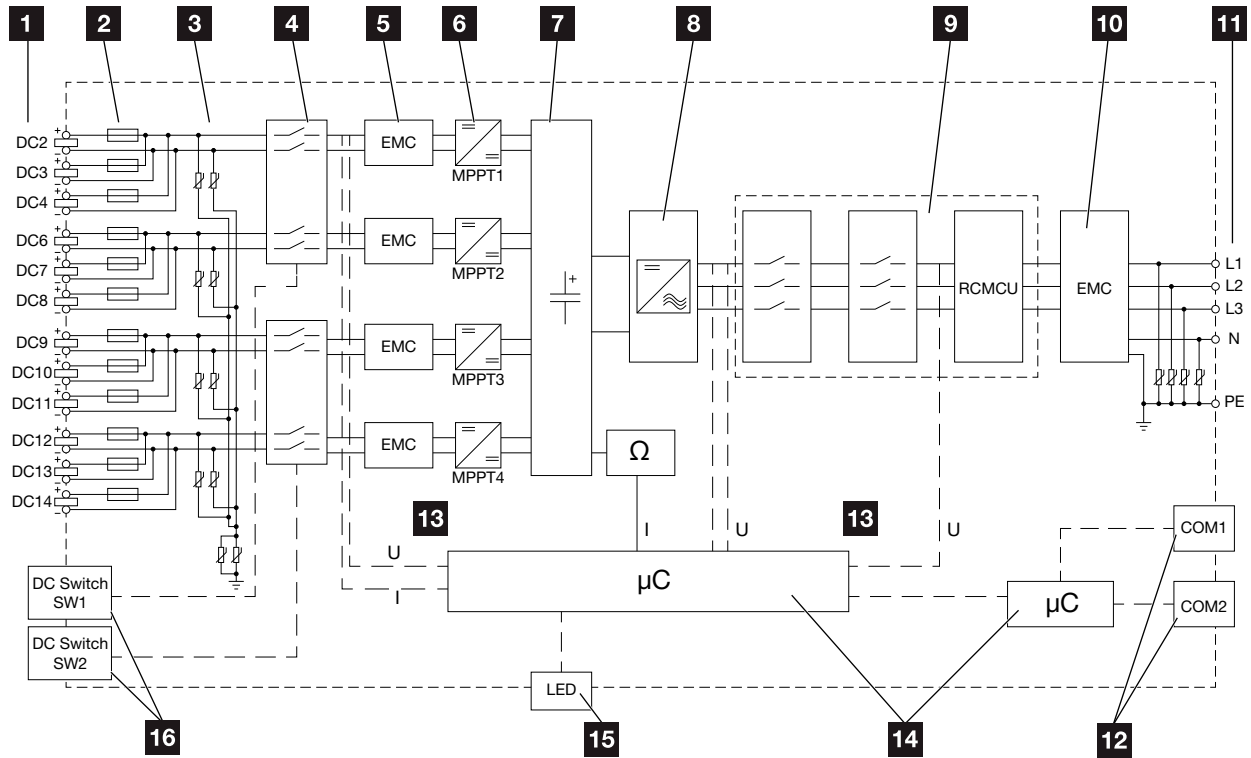
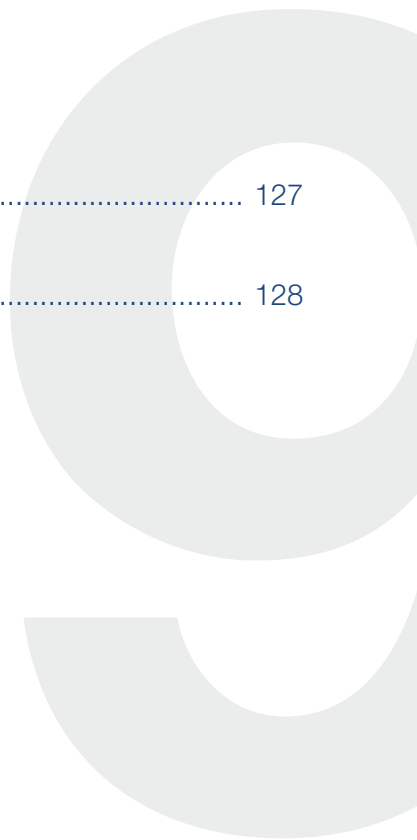

Fig. 36: Block diagram for PIKO CI 60

- 1** DC inputs for PV modules
- 2** DC fuses
- 3** Integrated overvoltage protection (DC side)
- 4** Electronic DC disconnection device
- 5** EMC filter (DC side)
- 6** DC regulator
- 7** Intermediate circuit
- 8** Inverter bridge circuit
- 9** Grid monitoring and shut-down
- 10** EMC filter (AC side)
- 11** AC connection
- 12** COM1 and COM2 connection panels for communication interfaces
- 13** Voltage and current measurement
- 14** Control system and communication
- 15** Status LED
- 16** DC switch

9. Accessories

9.1	KOSTAL Solar Portal	127
9.2	KOSTAL Solar App	128



9.1 KOSTAL Solar Portal

The **KOSTAL Solar Portal** allows operation of the inverters to be monitored via the Internet. Registration for the **KOSTAL Solar Portal** is available free of charge on our homepage at www.kostal-solar-portal.com

Additional information about this product is available on our website www.kostal-solar-electric.com under **Products > Monitoring software > KOSTAL Solar Portal**.

9.2 KOSTAL Solar App

The free KOSTAL Solar App provides you with a way to professionally monitor your photovoltaic system. You can use the KOSTAL Solar App to simply and easily access all functions on your smartphone or tablet at any time.

To set up and use the app, you will need a user account on the **KOSTAL Solar Portal** and to have an inverter set up there. The same login details used for the **KOSTAL Solar Portal** are required to log in to the app.

You can use the KOSTAL Solar App to easily monitor your photovoltaic system and to display relevant system data both when you are out and about and at home. It allows you to access the consumption and generation data over various time periods, such as day, week, month and year, and to access the historical data of your photovoltaic system. In this way, the KOSTAL Solar App always keeps you up-to-date.

Download the free KOSTAL Solar App today and benefit from new and advanced functionalities.

Additional information about this product is available on our website www.kostal-solar-electric.com under **Products > Monitoring software > KOSTAL Solar App**.

10. Appendix

10.1 Type plate	130
10.2 Warranty and service	131
10.3 Handover to the operator	132
10.4 Decommissioning and disposal	133

10.1 Type plate

The type plate is located on the inverter. The type plate allows you to identify the device type, serial number and the most important technical data.

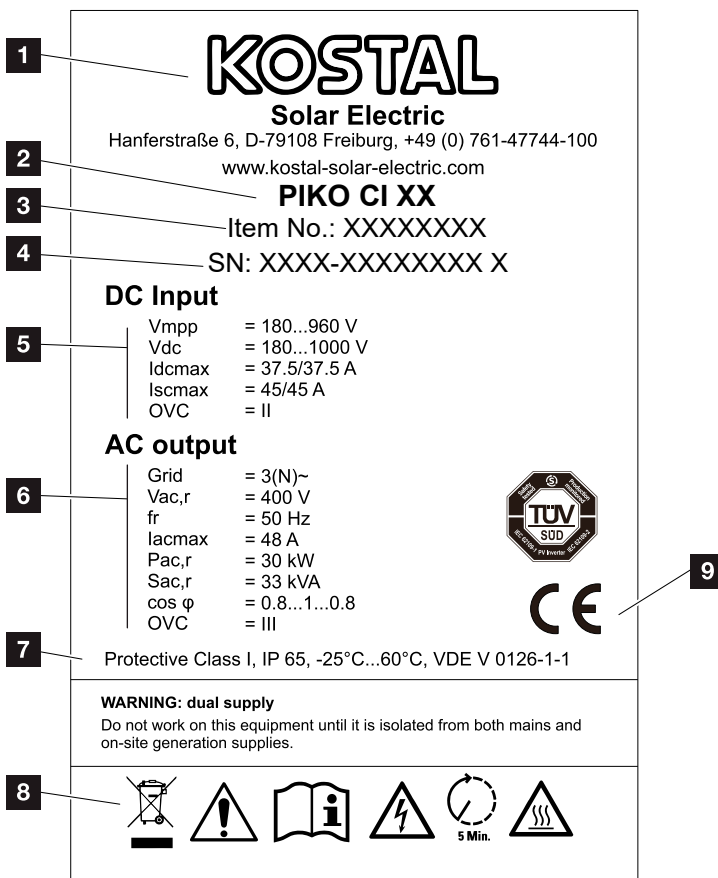

Fig. 37: Type plate

- 1 Name and address of manufacturer
- 2 Device type
- 3 KOSTAL article number
- 4 Serial number
- 5 Information on DC inputs:
 - input voltage range
 - max. input voltage
 - max. input current (PV modules per DC group)
 - max. short-circuit current (PV modules, per DC group)
 - overvoltage category
- 6 Details of the AC output:
 - number of supply phases
 - output voltage (nominal)
 - grid frequency
 - max. output current
 - max. output power
 - max. output apparent power
 - setting range of power factor
 - overvoltage category
- 7 Protective class in accordance with IEC 62103, protection class, ambient temperature range, overvoltage category, requirements with which the integrated grid monitoring complies
- 8 Warning symbols
- 9 CE mark

10.2 Warranty and service

The warranty period for the inverter is 2 years from the date of purchase. If you register the inverter with the KOSTAL Solar online shop within the first 6 months from the date of purchase, you can extend this free of charge to our KOSTAL 5-year Smart Warranty.

You can find more information about the service and warranty conditions in the download area for the product on our website at www.kostal-solar-electric.com.

For service information and in the event of parts being needed, we require your device type and the serial number. You will find this information on the type plate on the exterior of the housing.

If parts are required, use only original replacement parts.

If you have any technical questions, please call our service hotline:

- Germany and other countries¹
+49 (0)761 477 44 - 222
- Switzerland
+41 32 5800 225
- France, Belgium, Luxembourg
+33 16138 4117
- Greece
+30 2310 477 555
- Italy
+39 011 97 82 420
- Spain, Portugal²
+34 961 824 927

¹ Language: German, English

² Language: Spanish, English

10.3 Handover to the operator

After successful installation and commissioning, hand over all documents to the operator.

Show the operator how to use the photovoltaic system and the inverter. In particular, draw his attention to the following points:

- Position and function of the DC switches
- Position and function of the AC line circuit breaker
- Procedure for disconnecting the device
- Safety when handling the device
- Appropriate procedure when checking and servicing the unit
- Meaning of the LEDs and the information in the app
- Contact person in the event of a fault



Ideally, you should provide the operator with system and test documentation in accordance with DIN EN 62446 (VDE 0126-23) (optional) to protect him and yourself.

As installer and commissioning engineer, have the operator confirm the proper handover with his signature.

As the operator, have the installer and commissioning engineer confirm the standard-compliant and safe installation of the inverter and the PV system with his signature.

10.4 Decommissioning and disposal

To remove the inverter, proceed as follows:

1. De-energise inverter on AC and DC sides.
 **Ch. 4.3** 
2. PIKO CI 50/60: Open the lower cover of the inverter.
3. Loosen terminals and cable glands.
4. Remove all DC and AC cables and communication cables.
5. PIKO CI 50/60: Close the inverter cover.
6. Loosen locking screw on inverter's bracket.
7. Lift inverter off the wall.



DANGER

RISK OF DEATH DUE TO ELECTRICAL SHOCK AND DISCHARGE!

De-energise device and secure against being switched on again.

 **Ch. 4.3**

Proper disposal

Electronic equipment labelled with a dustbin with a line through it may not be disposed of with household waste. This equipment can be handed in to waste collection points free of charge.



Find out about the local requirements for the separate collection of electrical and electronic equipment in your country.

Index

A

Accessories 126

B

Block diagram 123

C

Cable 121

Current operating manual 10

D

Data export 103

DC cables 133

DC switch 77, 78

Disposal 133

E

Ethernet 47, 50

EU declarations of conformity 9

Event messages 113

G

Grid monitoring 130

H

Hotline 3, 131

I

Initial commissioning 73, 74

Interfaces 121

L

Language 2

Line circuit breaker 38, 76, 78

Log data 101, 102, 103

N

Notes 10, 12, 15

P

Proper use.....7
PV generator 120

S

Safety instructions 12
Scope of delivery 31
Settings 88
Solar portal..... 102
Storage 30

T

Technical data 119
Transport 30
Troubleshooting 115
Type plate..... 112, 130, 131

W

Warnings 13
Warranty..... 8, 131

KOSTAL

KOSTAL Solar Electric GmbH
Hanferstr. 6
79108 Freiburg i. Br.
Germany
Telephone: +49 761 47744 - 100
Fax: +49 761 47744 - 111

KOSTAL Solar Electric Ibérica S.L.
Edificio abm
Ronda Narciso Monturiol y Estarriol, 3
Torre B, despachos 2 y 3
Parque Tecnológico de Valencia
46980 Valencia
España
Teléfono: +34 961 824 - 934
Fax: +34 961 824 - 931

KOSTAL Solar Electric France SARL
11, rue Jacques Cartier
78280 Guyancourt
France
Téléphone: +33 1 61 38 - 4117
Fax: +33 1 61 38 - 3940

KOSTAL Solar Electric Hellas E.Π.Ε.
47 Steliou Kazantzidi st., P.O. Box: 60080
1st building – 2nd entrance
55535, Pilea, Thessaloniki
Ελλάδα
Τηλέφωνο: +30 2310 477 - 550
Φαξ: +30 2310 477 - 551

KOSTAL Solar Electric Italia Srl
Via Genova, 57
10098 Rivoli (TO)
Italia
Telefono: +39 011 97 82 - 420
Fax: +39 011 97 82 - 432