

Mounting instructions

trapezoidal metal – slight elevation

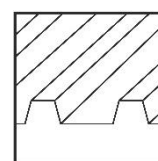

TABEL OF CONTENTS

1	Notes	1
2	Maintenance of the mounting system	4
3	novotegra for trapezoidal metal – slight elevation	4
4	System components, tools and equipment	5
4.1	Required assembly equipment	5
4.2	Mounting system components – mounting variations	6
4.3	Mounting system components – optional	7
5	Installing the supporting structure	7
5.1	Direct mounting of short profiles.....	8
5.2	Mounting the support.....	9
5.3	Installing the modules.....	10
5.4	Transverse mounting variation	11
6	Warranty / product liability (exclusion)	12

1 Notes

The following instructions are generally valid for our mounting system novotegra and are to be applied or interpreted accordingly regardless of the respective roof and mounting system type.

Safety information

Mounting tasks may only be carried out by qualified and competent persons. During the work protective clothing in accordance with the relevant national regulations and guidelines must be worn.

Mounting must be carried out by at least two persons to ensure help in case of an accident.

All relevant national and locally applicable health and safety regulations, accident prevention regulations, standards, construction standards and environmental protection regulations as well as all regulations of the employers' liability insurance associations must be complied with.

The national regulations for working at height / on the roof must be complied with.

Electrical work must be carried out in compliance with the national and locally applicable standards and guidelines and the safety rules for electrical work.

Earthing / equipotential bonding of the mounting system must be carried out in accordance with the national and locally applicable standards and guidelines.

Categorisation into hazard classes

To alert the user of potential danger situations the hazard classes analogous to ANSI Z 535 are used. The hazard class describes the risk if the safety information is not observed.

Warning symbol with signal word

Hazard class analogous to ANSI Z 535



DANGER! describes an immediate danger. If it is not avoided, death or serious injury will result.

WARNING! describes a potential danger. If it is not avoided, death or serious injury might result.

CAUTION! describes a potential danger. If it is not avoided, light or minor injury might result.

NOTE! describes a potentially harmful situation. If it is not avoided, the plant or objects in its vicinity might be damaged.

General information

After receipt the goods must be inspected for completeness using the accompanying delivery note.

novotegra GmbH does not accept the costs, nor can we guarantee subsequent express deliveries if missing material is only noticed during mounting.

Since our mounting systems are subject to continuous development, mounting processes or components may change. Therefore, please check the current status of the mounting instructions on our website prior to mounting. We are also happy to send you current versions upon request.

The mounting system is suitable for the attachment of PV modules with standard market dimensions. Please find more detailed information about this in chapter 3.

The usability of the mounting system for the respective project must be checked for each individual case on the basis of the roof cover / roof construction / facade present.

The roof cover / roof construction / facade must meet the requirements of the mounting system with regard to load bearing capacity, support structure and condition.

Requirements for the material of the roof construction / roof cover / facade:

Wooden components (rafters/ purlins) at least strength class C24: no fungal decay or rottenness. OSB with material grade OSB 3.

Steel purlins for stock screw installation exclusively material grade S235.

Tensile strength R_m , min for trapezoidal metal: steel 360 N/mm²; aluminium 195 N/mm²

Wall construction material: concrete, brick or sand-lime brick in solid or hollow block design.

The load bearing capacity of the roof / roof construction (rafters, purlins, trapezoidal metal, concrete floors, number of adhesive points, folded seams, etc.) or the facade (wall construction materials) must be checked by the user or a check be commissioned.

Physical building aspects concerning insulation penetrations (e.g. condensation) must be taken into account by the user.

Notes on mounting

The components of the novotegra mounting system are intended exclusively for the attachment of PV modules. Dependent on the roof type of the building the designated mounting system components must be used.

A condition for the intended use of the novotegra mounting system is the mandatory compliance with the specifications in these instructions regarding safety information and mounting.

In case of unintended use and non-compliance with the safety information and mounting instructions and non-utilisation of the corresponding mounting components or use of third party components not belonging to the mounting system any warranty and liability claims against the manufacturer are voided. The user is liable for damage and resulting consequential damage to other components, such as PV modules, or the building as well as personal injury.

The user must read the mounting instructions prior to mounting. Unresolved issues must be clarified with the manufacturer prior to mounting. The mounting sequence in these instructions must be adhered to.

It must be ensured that a copy of the mounting instructions is accessible in the immediate vicinity of the work on site.

The mounting specifications (module load, attachment, clamping areas etc.) of the module manufacturer must be observed and complied with.

Prior to mounting the mounting system must be statically calculated with the loads to be assumed for the building project in accordance with the national standards. Information relevant to mounting (e.g. roof hook distance, lengths of bolts, overhang and protrusions or distance of base trough and required ballast) must be determined by the static calculation using the design software www.solar-planit.

The permissible roof inclination for using the mounting system according to these installation instructions is 0 to 60 degrees for roof-parallel installation on a pitched roof and 0 to 5 degrees for elevated installation on a flat roof. Facade systems must be mounted parallel to the facade.

For roof-parallel installation with the clamping system, two module support rails per module must be mounted symmetrically under the modules for equal load transfer into the substructure. Alternatively, the roof-parallel installation can also be installed with insertion rails.

The specified tightening torques must be adhered to and checked randomly on site.

Notes on static calculations

The mounting system must generally be statically calculated for each individual project using the design software Solar-Planit. Excluding façade systems, the calculation for this will be carried out by the company novotegra GmbH.

The static calculation only determines the load bearing capacity of the novotegra mounting system and also takes account of the attachment to the building (rafters, purlins, trapezoidal metal, facade etc.). The load transfer within the building is not considered (customer static calculations).

The load bearing capacity of the mounting system components is determined on basis of the planned module layout and the underlying building information (project data recording). Deviations from the planning on site may lead to different results.

The load assumptions (load and roof division) are country-specific in accordance with the specifications of the Eurocode load standards. The determination of the loads to be assumed for Switzerland is in accordance with SIA 261.

At pitched roof, the modules may not be fitted above the gable end, ridge and eaves or the facade (increased wind load). At the ridge the modules may be fitted up to max. a theoretical horizontal line with the ridge tile and perfectly flush with the gable end. In the eaves area the modules may reach to max. the end of the roof cover due to loads.

In case of an exposed building position (with wind load e.g. at the edge of a slope) or snow accumulation (e.g. dormer or catchment grill or roof structures like domelights etc) the specifications of the Eurocode load standards or SIA 261 (Switzerland) must be taken into account by the user within his own responsibility. The design software does not consider these cases.

The static calculation of the mounting system is based on the symmetrical placement of the modules on the mounting rails at the longitudinal side of the modules (roof-parallel clamping systems) or on the support components (elevation) for equal load transfer into the substructure. For the insertion system a cross rail arrangement is expected for equal load transfer.

The results calculated with the design software, such as distances of the fasteners (e.g. roof hooks, stock screws, saddle clamps etc.), rail lengths and number of fasteners (e.g. direct attachment on the trapezoidal metal), overhang (e.g. rail and roof hook protrusions) or distances between the base troughs and number of fixing materials (e.g. rail joint) and the other calculation notes must be considered and complied with.

novotegra has been tested and certified by TÜV Rheinland:



2 Maintenance of the mounting system

The mounting system must be checked for stability and operation at regular intervals during the system maintenance.

In addition to the visual inspection of the components, we recommend a random check of the connections and the safe and correct position of the ballast on the base rails and ballast troughs.

Removal is possible in reverse order in the work steps mentioned below.

The maintenance work must be carried out by a specialist company with proven experience in electrical systems and work on mounting systems.

3 novotegra for trapezoidal metal – slight elevation

The contents of this installation manual describe the installation of the supporting structure on roofs with a trapezoidal sheet metal covering at a roof pitch of 5 to 20 degrees. A slight elevation of approx. 5° can be achieved for the photovoltaic modules by using two additional support components.

Depending on the mounting system design, the impact of wind and snow affects the roofing as single or linear loads. The structural analysis of the mounting system only takes into account the attachment of the supporting structure to the roofing. The static calculation of the roofing based on the load from the photovoltaic structure must be prepared on site. Structures are attached to the roofing using thin sheet metal screws approved by the building authorities for sheet thicknesses of at least 0.4 mm (steel sheet) or 0.5 mm (aluminium sheet). A minimum sheet thickness of 0.7 mm is recommended when using aluminium sheet.

General conditions to be observed:

- Roof pitch = 5–20 degrees
- Module length = max. 2.1 m
- Module width = max. 1.14 m
- Elevation angle = approx. 5°
- Distance from edge = 10 cm
- Distance between rows = refer to planning documents
- Max. module field length parallel to eaves = 18m (refer to planning documents)

4 System components, tools and equipment

4.1 Required assembly equipment















Figure	Tool	Component*	Product group
		Module support 5° (low) Material: Aluminium (Module for vertical/transverse mounting)	Profile rails
		Module support 5° (high) Material: Aluminium (Module for vertical/transverse mounting)	Profile rails
		Short profile C24/C47, 385 mm Material: Aluminium and EPDM (Module for vertical/transverse mounting)	Profile rails
		Trapezoidal mounting screw SL 5.5 x 25 mm, E11 Tool: Socket bit AF 8 (Module for vertical/transverse mounting)	Roof mounting
		Trapezoidal mounting screw SL 6.0 x 25 mm, E16 Tool: Socket bit AF 8 (Module for vertical/transverse mounting)	Roof mounting
		Middle clamp set C Material: Aluminium, cast aluminium and stainless steel Tool: Socket bit AF 8	Module mounting
		End clamp set C Material: Aluminium, cast aluminium and stainless steel Tool: Socket bit AF 8	Module mounting

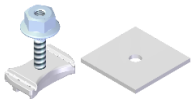





Figure	Tool	Use for tool	Application
	Cordless screwdriver	Socket bit AF 8	Component connections Clamp assembly
	Torque key up to at least 10 Nm	Socket bit AF 8	Clamp assembly

4.2 Mounting system components – mounting variations

Figure	Tool	Component**	Product group
		Short profile C24/C47, 385 mm Material: Aluminium and EPDM (Module for transverse mounting)	Profile rail
		Trapezoidal mounting screw SL 5.5 x 25 mm, E11 Tool: Socket bit AF 8 (Module for vertical/transverse mounting)	Roof mounting

**Required components depending on supporting structure construction (e.g. rail sections sawn on site), system design (e.g. insertion rails on short profile) or module arrangement (e.g. transverse module mounting).

4.3 Mounting system components – optional

Figure	Tool	Component***	Product group
		Fastening set C M8 with washer	Accessories and optional components
		Cable-tie clip for profile flange	Cable protection
		Cable clip d = 10 mm	Cable protection
		Contact latch module clamp	Accessories and optional components
		Repair screw SL 7.2 x 9 mm Tool: Socket bit AF 8	Roof mounting

***Optionally available mounting system components for applications such as improving the aesthetics of the system, cable management or grounding the installation system.

5 Installing the supporting structure

Prior to installation, it is important to measure out the module field on the roof and determine the position of the fixings (e.g. roof hooks, hanger bolts, seam clamps and short profiles), taking into account the static calculation.

The individual mounting steps for vertical and transverse clamping system mounting are explained below. This is then followed by the respective work sequence.

5.1 Direct mounting of short profiles

Measuring the short profiles

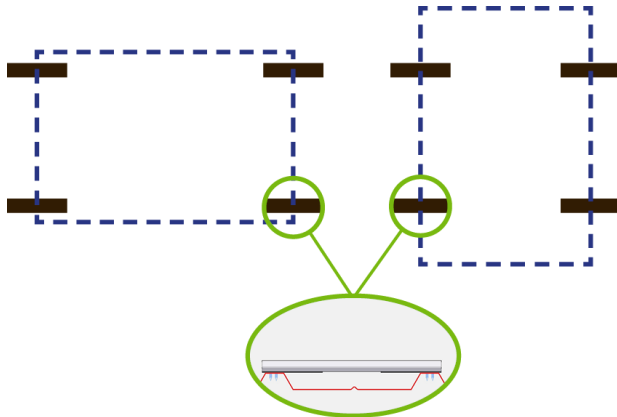

Position the short profiles at right angles depending on the module orientation. The system planning must be taken into account.

⚠ WARNING

Scaffolding must be erected in accordance with the relevant specifications before carrying out the work.

Securing the short profiles

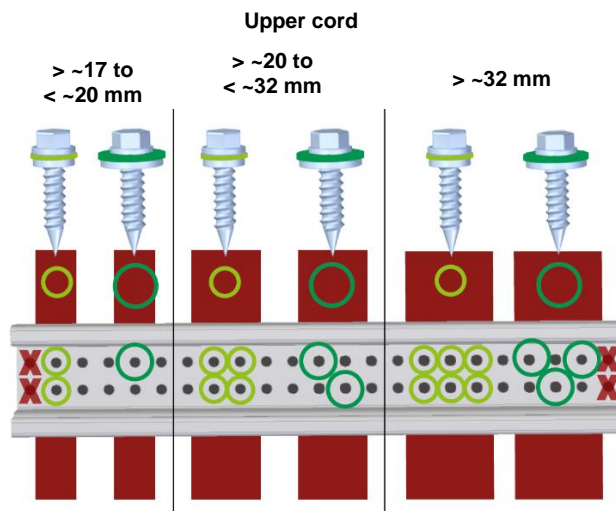

The static calculation during the system planning process determines the number and arrangement of the required fixings for module mounting.

The choice of fixings depends on the width of the raised bead and the diameter (11 mm or 16 mm) of the sealing washer.

The required number of fixings according to the design software are to be distributed across the raised bead as shown.

NOTICE

The thin sheet metal screws must be screwed at right angles to the raised beads but not overtightened.

⚠ WARNING

The outermost drill holes on the short profile C24 385 mm are not to be used for fastening.

Short profile out-to-in measurement

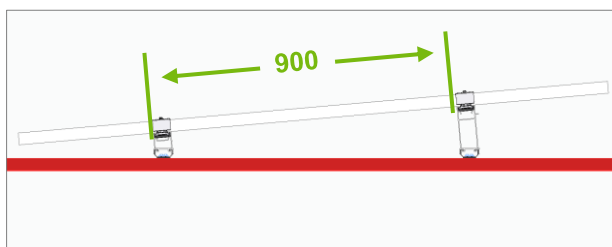

The out-to-in measurement from short profile to short profile is 900mm (+/-100mm) and depends on the module dimensions. The system planning must be taken into account.

NOTICE

Allowed module width: 990–1400 mm
Allowed module length: 990–2100 mm

5.2 Mounting the support

Positioning the supports

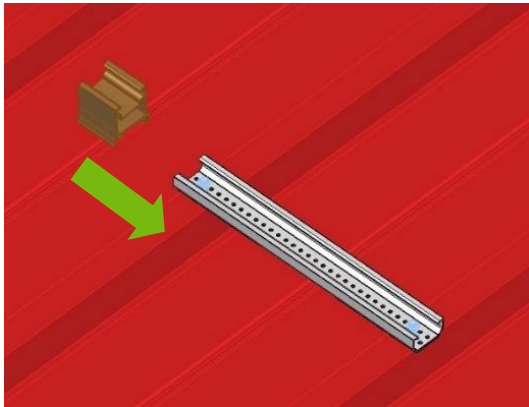

Push the support onto the side of the short profile and position it between the fixing points. The angle of the supports must be aligned along the roof pitch.

NOTICE

Be sure to measure the module field beforehand, as the support must not be positioned in the overhang of the short profile to the raised bead.

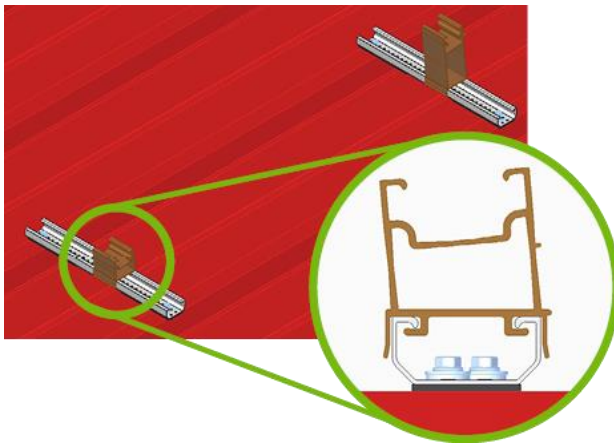

Mounting the middle and end clamps

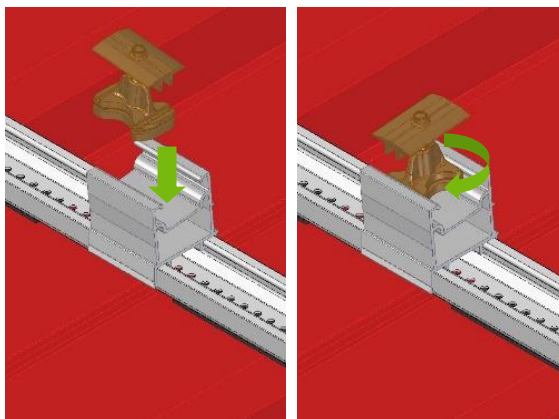

At the clamping point, guide the middle and end clamps into the rail chamber from the top. Then turn the rail nut inside the rail and push the module clamps onto the module frame. Alternatively, the clamp can be pushed into the profile from the side.

NOTICE

See MV 3 for contact latch installation

Clamp position

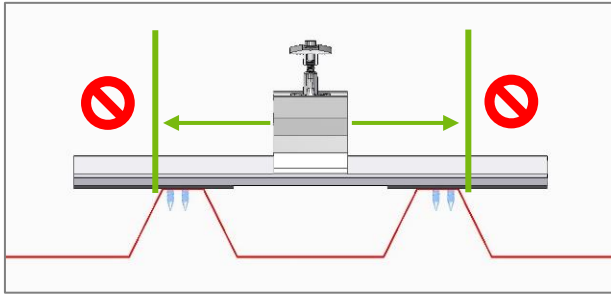

Position the middle clamps centrally on the module supports.

Middle clamp fastening torque 10 Nm

NOTICE

For middle and end clamp space requirements, refer to MV 2

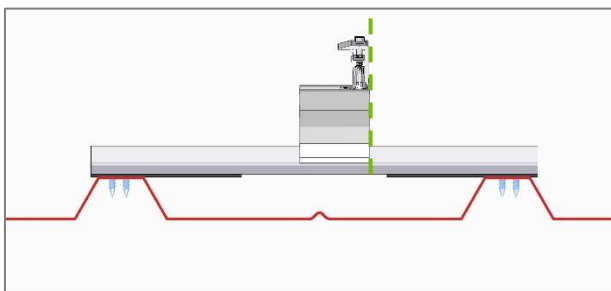

Position the end clamp on the module support. The position of the clamp must not be flush with the edge of the support. The flat surface of the clamp must not protrude beyond the support.

End clamp fastening torque 8 Nm

NOTICE

For middle and end clamp space requirements, refer to MV 2

5.3 Installing the modules

Clamping modules

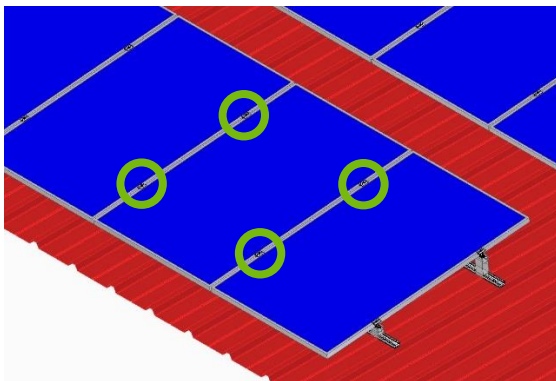

The modules are to be fixed to the supports with end and middle clamps.

NOTICE

For vertical and transverse module mounting, refer to MV 1

Securing the system

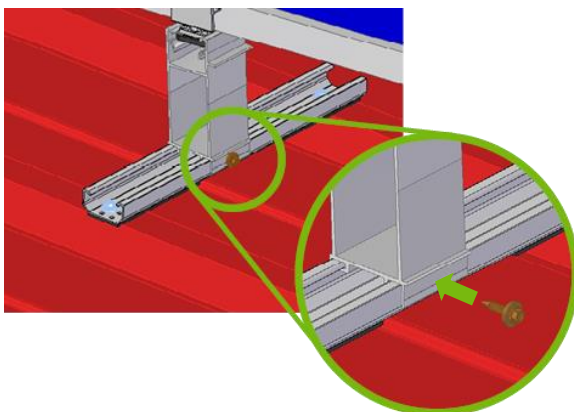

The outermost high support at the edge of the module field must be screwed to the short profile with a thin sheet metal screw.

NOTICE

Place the screw tip in the bevel of the module support.

5.4 Transverse mounting variation

This section covers the various mounting variations depending on the design variant (e.g. rail sections or modules with box frames).

MV 1: Short profile variations for transverse mounting

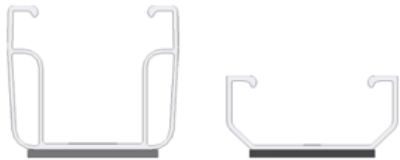

Short profile C47
with EPDM 385 mm

Short profile C24
with EPDM 385 mm

Transverse module mounting can be carried out with short profile C24 or C47, following the assembly steps in the same sequence as described in Chapter 5.1.

NOTICE

The thin sheet metal screw must not be overtightened.

Clamping modules

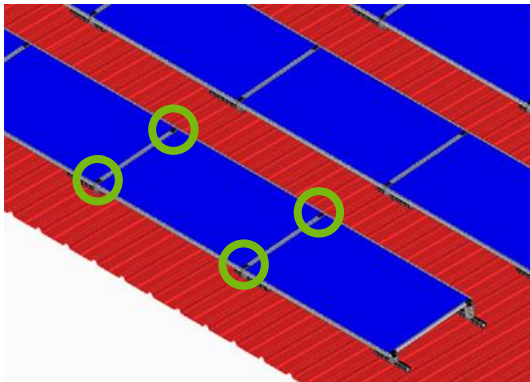

The module is clamped on the short side of the frame.

NOTICE

It may be necessary to obtain the approval of the module manufacturer. It may not be possible to install oversized modules transversely.

MV 2: Middle and end clamp space requirements

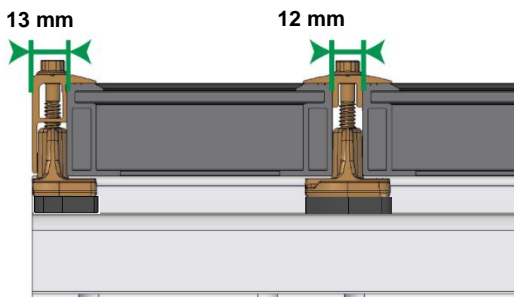

End clamps may be installed flush with the rail end.

Push module completely onto the rail nut of the middle clamps.

NOTICE

Middle clamp fastening torque 10 Nm
End clamp fastening torque 8 Nm

MV 3: Grounding the contact latch

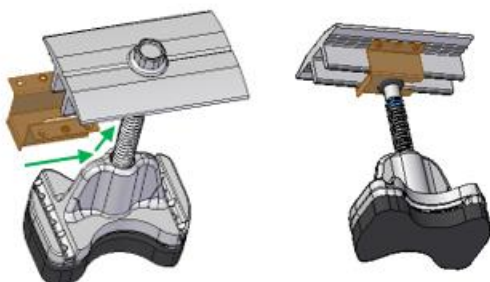

Use the sliding clip to push the contact latch over the vertical bridges of the middle clamps up to the screw.

NOTICE

The middle clamp with the contact latch in place is installed as previously described in Chapter 5.2.

6 Warranty / product liability (exclusion)

In addition to the above-mentioned regulations and safety notices the applicable regulations and rules of technology must be observed by the installing specialist company.

The installer is responsible for the dimensioning of the mounting system.

The installer is responsible for the connection of the interfaces between the mounting system and the building. This also includes the tightness of the building envelope.

For flat roofs the roof insulation must be evaluated by the installer on site within his own responsibility regarding the material of the sealing layer, resistance, ageing, compatibility with other materials, overall condition of the roof insulation, need for a separating layer between the roof insulation and the mounting system. The required and necessary measures or precautions for the protection of the roof insulation for the mounting of the substructure of a PV system must be initiated by the installer with the aid of a specialist tradesman where necessary. novotegra GmbH does not accept liability for faulty or inadequate measures and precautions for the protection of the roof insulation!

The installer must review the friction coefficient used in the calculation for the verification of the slip safety of PV systems on flat roofs on site. Friction coefficients determined on site can be taken into account by entering them in the Solar-Planit planning tool. novotegra GmbH does not guarantee the correctness of the assumed values and is not liable for damage due to the use of incorrect values.

The specifications of the module, cable and inverter manufacturers must be observed. If these contradict the mounting instructions, always consult the novotegra GmbH sales team before mounting the novotegra mounting system or – in the case of components not supplied by novotegra GmbH – the manufacturer concerned.

During the preparation of the offers for novotegra by our sales staff the local conditions are not always sufficiently known, which is why changes to the offered quantities may result during installation. These changes relate mainly to the number of fasteners for the building envelope (for example roof hooks). In this case the additionally required components must always be installed in accordance with the dimensioning.

novotegra GmbH is not liable for incorrect or incomplete data collection sheets. Error-free and fully completed data collection sheets are essential for correct dimensioning.

The information in the mounting instructions, the warranty terms and the information about the liability exclusion must be noted.



novotegra

novotegra GmbH

Eisenbahnstraße 150
72072 Tübingen | Deutschland

Tel. +49 7071 98987-0
Fax +49 7071 98987-10

info@novotegra.com
www.novotegra.com

